

P1394.3

Draft Standard for a High Performance Serial Bus Peer-to-Peer Data Transport Protocol (PPDT)

Sponsor

**Microprocessor and Microcomputer Standards Committee
of the
IEEE Computer Society**

Not yet approved by

IEEE-SA Standards Board

Not yet approved by

American National Standards Institute

Abstract: This standard defines a peer-to-peer data transport (PPDT) protocol between Serial Bus devices that implement ANSI NCITS 325-1998, Serial Bus Protocol 2. The facilities specified include device and service discovery, self-configurable (plug and play) binding, and connection management.

Keywords: computers, CSR architecture, connect, peer-to-peer, SBP-2, transport protocol

Copyright © 2000 by the Institute of Electrical And Electronics Engineers, Inc
345 East 47th Street,
New York, NY 10017, USA
All rights reserved

This is an unapproved IEEE Standards Project, subject to change. Permission is hereby granted for IEEE Standards Committee participants to reproduce this document for purposes of IEEE standardization activities, including balloting and coordination. If this document is to be submitted to ISO or IEC, notification shall be given to the IEEE Copyrights Administrator. Permission is also granted for member bodies and technical committees of ISO and IEC to reproduce this document for purposes of developing a national position. Other entities seeking permission to reproduce this document for these or other uses must contact the IEEE Standards Department for the appropriate license. Use of the information contained in this unapproved draft is at your own risk.

IEEE Standards Department
Copyrights and Permissions
445 Hoes Lane, PO Box 1331
Piscataway, NJ 08855-1333, USA

IEEE Standards documents are developed within the IEEE Societies and the Standards Coordinating Committees of the IEEE Standards Board. Members of the committees serve voluntarily and without compensation. They are not necessarily members of the Institute. The standards developed within IEEE represent a consensus of the broad expertise on the subject within the Institute as well as those activities outside of IEEE that have expressed an interest in participating in the development of the standard.

Use of an IEEE Standard is wholly voluntary. The existence of an IEEE Standard does not imply that there are no other ways to produce, test, measure, purchase, market, or provide other goods and services related to the scope of the IEEE Standard. Furthermore, the viewpoint expressed at the time a standard is approved and issued is subject to change brought about through developments in the state of the art and comments received from users of the standard. Every IEEE Standard is subjected to review at least every five years for revision or reaffirmation. When a document is more than five years old and has not been reaffirmed, it is reasonable to conclude that its contents, although still of some value, do not wholly reflect the present state of the art. Users are cautioned to check to determine that they have the latest edition of any IEEE Standard.

Comments for revision of IEEE Standards are welcome from any interested party, regardless of membership affiliation with IEEE. Suggestions for changes in documents should be in the form of a proposed change of text, together with appropriate supporting comments.

Interpretations: Occasionally questions may arise regarding the meaning of portions of standards as they relate to specific applications. When the need for interpretations is brought to the attention of IEEE, the Institute will initiate action to prepare appropriate responses. Since IEEE Standards represent a consensus of all concerned interests, it is important to ensure that any interpretation has also received the concurrence of a balance of interests. For this reason, IEEE and the members of its societies and Standards Coordinating Committees are not able to provide an instant response to interpretation requests except in those cases where the matter has previously received formal consideration.

Comments on standards and requests for interpretations should be addressed to:

Secretary, IEEE Standards Board
445 Hoes Lane
PO Box 1331
Piscataway, NJ 08855-1331
USA

Introduction

(This introduction is not part of the draft standard, IEEE P1394.3, Standard for a High Performance Serial Bus Peer-to-Peer Data Transport Protocol)

The IEEE approved project P1394.3 on January 30, 2000, at the request of Gregory LeClair, then Chair of the 1394 Printer Working Group, an informal industry consortium. Although final approval of this standard has taken place under the aegis of the IEEE, most of the significant effort occurred prior to the formation of the P1394.3 working group.

The necessity for a Serial Bus transport protocol for printers and similar devices was first broached in hallway conversation at the quarterly meeting of the 1394 Trade Association in Redmond, WA, in October, 1996. This led to a “birds of a feather” assembly hosted at Adobe Systems in San Jose, CA, on December 6 that same year. The attendees at this crowded gathering discussed the suitability of existing protocols, particularly SBP-2, and the venue for the proposed standards work. The group concluded that no existing protocol suited their needs: one would have to be developed. Don Wright offered the services of the Printer Working Group, an *ad hoc* industry forum whose principal participants are printer vendors, and Greg LeClair wrote the initial charter for the group.

The first official meeting of the 1394 Printer Working Group was held in Albuquerque, NM, early in 1997. Consensus was quickly reached that the new protocol must be friendly to legacy data formats; this exposed the two major areas that occupied the working group for the next three years: a) device discovery and enumeration and b) a data transport protocol.

The working group examined the facilities of IEEE Std 1394-1995 and the CSR architecture and concluded that configuration ROM might permit practical solutions for device discovery but that the current standard, ISO/IEC 13213:1994, did not adequately specify the necessary building blocks. The 1394 Printer Working Group applied to the IEEE Microprocessor and Microcomputer Standards for a project authorization request (PAR) to commence new work. Simultaneously, the CSR architecture was due for revision and the MMSC approved a PAR for IEEE P1212 and suggested to the 1394 Printer Working Group that work be transferred to the IEEE. In fact, many participants became simultaneously active in the IEEE P1212 working group and provided strong continuity between the two complementary efforts. At the time of writing, draft standard IEEE P1212 is in the ballot process and is likely to be an approved standard by the end of 2000.

With work on device discovery split off to IEEE P1212, the 1394 Printer Working Group was free to focus its efforts on the transport protocol. There were two principal candidates, SBP-2 and the “thin” protocol jointly developed by camera and printer companies in Japan. No matter which protocol (or adaptation thereof) was ultimately chosen, the 1394 PWG thought it was important to recognize the peer-to-peer nature of the desired operating environment. The working group concluded that a solution similar to the “sockets” API that supported confirmed, efficient bi-directional data delivery between peers would suit their needs. Close to a year was spent debating the pros and cons of different approaches. In the end, the group converged on ANSI NCITS 325-1998 as the underlying mechanism: the 1394 PWG would focus its efforts on enhancements to SBP-2 to render it more fully peer-to-peer.

Once the selection of an underlying protocol was agreed, work progressed fairly quickly on what was eventually dubbed PPDT: peer-to-peer data transport protocol. The prototype efforts expended by some early adopters, both in Japan and the United States have been invaluable in the resolution of detailed technical questions that arose as this document was refined. In particular, the essential mechanisms first proposed as the Simple High Performance Transport (SHPT) were ultimately adopted. SHPT took advantage of the SBP-2 unordered execution model to provide independent, bi-directional data transport within the context of a single SBP-2 login. SHPT also optimized error recovery operations after bus reset by using execution context information known by both initiator and target.

Towards the end of summer 1999 it was apparent that the work neared conclusion; at this time the working group discussed possible homes for the draft standard and agreed upon the IEEE as the best choice.

Patent notice

NOTE – Attention is called to the possibility that implementation of this standard may require use of subject matter covered by patent rights. By publication of this standard, no position is taken with respect to the existence or validity of any patent rights in connection therewith. The IEEE shall not be responsible for identifying all patents for which a license may be required by an IEEE standard or for conducting inquiries into the legal validity or scope of those patents that are brought to its attention.

The patent holder has, however, filed a statement of assurance that it will grant a license under these rights without compensation or under reasonable rates and nondiscriminatory, reasonable terms and conditions to all applicants desiring to obtain such a license. The IEEE makes no representation as to the reasonableness of rates and/or terms and conditions of the license agreement offered by the patent holder. Contact information may be obtained from the IEEE Standards Department.

Committee membership

The following is a list of active participants in the IEEE P1394.3 working group (those who attended more than three meetings from original inception of the predecessor Printer Working Group activity to the time of publication).

Gregory LeClair, *Chair*
Alan Berkema, *Vice Chair*
Peter Johansson, *Editor*
Lee Farrell / Larry Stein, *Secretaries*

Brian Batchelder
Alan Berkema
Scott Bonar
Mike Fenelon
Doug Fritz
John Fuller
Osamu Hirata
Takashi Isoda
Laurie Lasslo

Bob Morford
Fumio Nagasaka
Brian Nagy
Atsushi Nakamura
Kazuo Nomura
Chuck Rice
Fumio Samitsu
Yuji Sasaki
Hitoshi Sekine

Akihiro Shimura
Nobuhiko Shinoda
Greg Shue
Larry Stein
Jerry Thrasher
Randy Turner
Shigeru Ueda
Rainier Wolfcastle
Don Wright

The following people were members of the balloting group:

The following people served on the ballot response committee:

Working group points of contact

Chair:

Gregory LeClair
Seiko Epson Corporation
150 River Oaks Pkwy., Suite 200
San Jose, CA 95134

(408) 576-4145
(408) 474-0511 FAX
greg@erc.epson.com

Vice Chair:

Alan Berkema
Hewlett-Packard Company
8000 Foothills Blvd., MS 5558
Roseville, CA 95747-5558

(916) 785-5605
(916) 785-1195 FAX
alan_berkema@hp.com

Editor:

Peter Johansson
Congruent Software, Inc.
98 Colorado Avenue
Berkeley, CA 94707

(510) 527-3926
(510) 527-3856 FAX
pjohansson@acm.org

Secretaries:

Lee Farrell
Canon Information Systems
110 Innovation Drive
Irvine, CA 92612

(949) 856-7163
(949) 856-7510 FAX
lfarrell@cis.canon.com

Larry Stein
Warp Nine Engineering
3645 Ruffin Rd., Suite 330
San Diego, CA 92123

(858) 292-2742
(858) 292-8020 FAX
lstein@fapo.com

Home page:

<http://grouper.ieee.org/groups/1394/3>

Reflector:

P1394@PWG.org
Majordomo@PWG.org (to subscribe)

Revision history

Draft 1.1 (February 10, 2000)

First release of a document as the work product of the IEEE P1394.3 working group; it is based upon efforts to date in 1394 Printer Working Group predecessor documents.

Draft 1.2 (June 26, 2000)

Minor typographical corrections discussed by the working group on the P1394@PWG.org reflector.

Draft 2.0 (July 29, 2000)

Identical to Draft 1.2 except for the removal of change bars, this draft was forwarded to the IEEE for initial sponsor ballot.

Contents

	Page
1 Overview	1
1.1 Scope	1
1.2 Purpose	1
2 Normative references	3
2.1 Approved references	3
2.2 References under development	3
2.3 Reference acquisition	3
3 Definitions and notation	5
3.1 Definitions	5
3.1.1 Conformance definitions	5
3.1.2 Technical definitions	5
3.1.3 Abbreviations	8
3.2 Notation	8
3.2.1 Numeric values	9
3.2.2 Bit, byte and quadlet ordering	9
4 Model (informative)	11
4.1 Protocol stack and service model	11
4.2 Independent data paths for each service	12
4.3 Connection management	13
4.4 Data transfer between initiator and target	14
4.5 Control requests and responses	15
4.6 Unsolicited status	16
4.7 Reverse login and logout	16
5 Data structures	19
5.1 Transport flow ORBs	19
5.2 Status block	20
5.3 Control information	22
5.4 Queue information	25
5.5 Reverse login request and response	26
6 Control operations	29
6.1 Login, reverse login and queue zero	29
6.2 Autonomous response information	30
6.3 Connection management	31
6.3.1 Connection establishment	31
6.3.2 Queue shutdown	32
6.4 Queue status information	35
6.5 Logout and reverse logout	35
7 Transport flow operations	37
7.1 Data transfer to a target	38
7.2 Data transfer to an initiator	39
7.3 Completion status	40
7.4 Execution context for active ORBs	41
7.5 Error recovery	41
8 Configuration ROM	45
8.1 Root directory	46
8.2 Instance directories	47

8.3 Feature directories	47
8.4 Keyword leaves	47
8.5 Initiator unit directory	48
8.6 Target unit directories	49
8.7 Private unit directory	50
8.8 Device ID	50

Tables

Table 1 – Parameter ID values	24
Table 2 – Connection type encoded by queue ID parameters	31
Table 3 – Root directory entries	46
Table 4 – Feature directory entries	47
Table 5 – Recommended keywords	48
Table 6 – Initiator unit directory entries	48
Table 7 – Target unit directory entries	49

Figures

Figure 1 – Bit ordering within a byte	9
Figure 2 – Byte ordering within a quadlet	9
Figure 3 – Quadlet ordering within an octlet	10
Figure 4 – Protocol stack (service at target)	11
Figure 5 – Protocol stack (service at initiator)	11
Figure 6 – Multiplexed queues in an SBP-2 task set	12
Figure 7 – Independent queues (logical model)	13
Figure 8 – Control request originated by initiator	15
Figure 9 – Control request originated by target	16
Figure 10 – Transport flow ORB	19
Figure 11 – Status block format	21
Figure 12 – Control information format	22
Figure 13 – Immediate parameter format	24
Figure 14 – Variable-length parameter format	25
Figure 15 – Queue information format	25
Figure 16 – Queue information byte format	26
Figure 17 – Reverse login request / response format	26
Figure 18 – Transport flow (datagram mode)	37
Figure 19 – Transport flow (stream mode)	37
Figure 20 – Transport flow (stream mode with explicit SDUs)	38
Figure 21 – Excess initiator data (datagram mode)	38
Figure 22 – Partial data transfer (stream mode)	39
Figure 23 – Excess target data (datagram mode)	40
Figure 24 – Example configuration ROM hierarchy	45
Figure 25 – First five quadlets of configuration ROM	45
Figure F-1 – Example bus information block and root directory	61
Figure F-2 – Feature directory with service ID leaf	62
Figure F-3 – Unit directory for peer-to-peer data transport (PPDT) protocol target	63
Figure F-4 – Instance directory and keyword leaf for a scanner	64
Figure F-5 – Instance directory and keyword leaf for a multiple protocol printer	65
Figure F-6 – Example MFP configuration ROM hierarchy	66
Figure F-7 – Instance directory and keyword leaf for a multifunction peripheral (MFP)	67
Figure F-8 – Initiator unit directory with a service ID leaf	68

Annexes

Annex A (normative) Minimum Serial Bus node capabilities51
Annex B (normative) Compliance with ANSI NCITS 325-199853
Annex C (normative) Control request and response parameters55
Annex D (normative) Control and status registers.....57
Annex E (normative) Service ID registration59
Annex F (informative) Configuration ROM61

1 Overview

1.1 Scope

This is a full-use standard whose scope is the definition of a peer-to-peer data transport (PPDT) protocol between Serial Bus devices that implement ANSI NCITS 325-1998, Serial Bus Protocol 2. The facilities specified include, but are not limited to, the following:

- Device and service discovery. PPDT devices may use uniform discovery procedures to locate other PPDT devices on the same bus. These procedures are extensible to an interconnected net of buses, when specified by IEEE P1394.1, Draft Standard for Serial Bus to Serial Bus Bridges. Once other PPDT devices are identified, facilities are provided to permit client applications to discover services;
- Self-configurable (plug and play) binding of device drivers to PPDT devices in a dynamic environment where users are free to insert and remove devices at will; and
- Connection management. A PPDT device (either an SBP-2 initiator or target) may establish and manage uni- or bi-directional connections for data transfer with other PPDT devices. The connections may be blocking or nonblocking, dependent upon application requirements, and operate independently of each other.

Although the original impetus for the development of this standard came from participants knowledgeable about printers and printing, the work evolved and became relevant to any application that requires efficient, peer-to-peer transport of data between devices.

1.2 Purpose

Experience with SBP-2 has demonstrated its high efficiency for the confirmed transport of large quantities of data between two devices. For historical reasons, SBP-2 is tailored to an environment where one device is the initiator (client) and the other the target (server); this is not necessarily the most natural approach when client applications and their associated servers may be located within initiator, target or both. Because SBP-2 is already widely implemented in operating systems, this standard leverages that effort in order to enhance the value of Serial Bus to devices in a wider range of operational circumstances.

This standard creates a new layer of protocol services based upon SBP-2 but that provides building blocks more suited to a peer-to-peer environment which includes printers, facsimile devices, scanners (or multifunction devices that present some combination of these capabilities) when a computer is present—but it is also intended to address the peer-to-peer needs of devices to communicate with each other in the absence of a computer.

2 Normative references

The standards named in this section contain provisions which, through reference in this text, constitute provisions of this standard. At the time of publication, the editions indicated were valid. All standards are subject to revision; parties to agreements based on this standard are encouraged to investigate the possibility of applying the most recent editions of the standards indicated below.

2.1 Approved references

The following approved standards may be obtained from the international and regional organizations that control them.

ANSI NCITS 325-1998, American National Standard for Information Systems – Serial Bus Protocol 2 (SBP-2)

ANSI X3.4-1986, American National Standard for Information Systems – Coded Character Sets – 7-Bit American National Standard Code for Information Interchange (7-Bit ASCII)

IEEE Std 1284-1994, Standard Signaling Method for a Bi-directional Parallel Peripheral Interface for Personal Computers

IEEE Std 1394-1995, Standard for a High Performance Serial Bus

IEEE Std 1394a-2000, Standard for a High Performance Serial Bus—Amendment 1

2.2 References under development

At the time of publication, the following referenced standards were under development.

IEEE P1212, Draft Standard for a Control and Status Register (CSR) Architecture for Microcomputer Buses

2.3 Reference acquisition

The references cited in the preceding clauses may be obtained from the organizations that control them:

American National Standards Institute (ANSI), 11 West 42nd Street, New York, NY 10036, USA; (212) 642-4900 / (212) 398-0023 (FAX); <http://www.ansi.org/>

Institute of Electrical and Electronic Engineers (IEEE)¹, 445 Hoes Lane, PO Box 1331, Piscataway, NJ 08855-1331, USA; (732) 981-0060 / (732) 981-1721 (FAX); <http://www.ieee.org/>

In addition, many of the documents controlled by the above organizations may also be ordered through a third party:

¹ Standards under development are not directly available from the IEEE; interested parties who wish to review or comment upon a draft standard may access the documents maintained by the working group. In the case of draft standard IEEE P1394a consult <ftp://ftp.t10.org/1394/P1394a/>; draft standard IEEE P1212 may be downloaded from <http://www.zayante.com/p1212/>.

Global Engineering Documents, 15 Inverness Way, Englewood, CO 80112-5776; (800) 624 3974 /
(303) 792-2192; <http://www.global.ihs.com/>

3 Definitions and notation

For the purposes of this standard, the following definitions, terms and notational conventions apply. IEEE Std 100-1992, The New IEEE Standard Dictionary of Electrical and Electronics Terms, should be consulted for terms not defined in this section.

3.1 Definitions

3.1.1 Conformance definitions

Several keywords are used to differentiate levels of requirements and optionality, as follows:

3.1.1.1 expected: A keyword used to describe the behavior of the hardware or software in the design models assumed by this standard. Other hardware and software design models may also be implemented.

3.1.1.2 ignored: A keyword that describes bits, bytes, quadlets, octlets or fields whose values are not checked by the recipient.

3.1.1.3 may: A keyword that indicates flexibility of choice with no implied preference.

3.1.1.4 reserved: A keyword used to describe objects—bits, bytes, quadlets, octlets and fields—or the code values assigned to these objects in cases where either the object or the code value is set aside for future standardization. Usage and interpretation may be specified by future extensions to this or other standards. A reserved object shall be zeroed or, upon development of a future standard, set to a value specified by such a standard. The recipient of a reserved object shall not check its value. The recipient of an object defined by this standard as other than reserved shall check its value and reject reserved code values.

3.1.1.5 shall: A keyword that indicates a mandatory requirement. Designers are required to implement all such mandatory requirements to assure interoperability with other products conforming to this standard.

3.1.1.6 should: A keyword that denotes flexibility of choice with a strongly preferred alternative. Equivalent to the phrase “is recommended.”

3.1.2 Technical definitions

The following terms are used in this standard:

3.1.2.1 active ORB: From the perspective of an initiator, an operation request block (ORB) in the target's task set, *i.e.*, an ORB for which completion status has yet to be stored at the initiator's *status_FIFO*. From the perspective of a target, an ORB for which the target maintains execution context.

3.1.2.2 active queue: A queue, created as part of a connection, for which target resources are allocated and into which an initiator is permitted to post ORBs. A queue remains active from its creation until it is shutdown.

3.1.2.3 blocking connection: A bi-directional connection that utilizes a single queue for data transfer both to and from a target. Because execution of transport flow ORBs within a queue is ordered, an uncompleted ORB for data transfer in one direction may block the execution of an ORB for data transfer in the other direction.

3.1.2.4 byte: Eight bits of data.

3.1.2.5 connection: A queue or a pair of queue(s) that affords access to a service. A connection may be unidirectional or bi-directional; in the latter case, a connection may be blocking or nonblocking. Two queues are necessary to implement a bi-directional, nonblocking connection.

3.1.2.6 control information: Information exchanged between initiator and target whose format is defined by this standard. The format of control information is independent of the format of application data exchanged by client applications and services—but both control information and application data are transported by the same methods.

3.1.2.7 control ORB: A transport flow ORB whose *queue* field is zero and whose *end_of_message* and *notify* bits are one; it is used to transfer request or response control information between initiator and target.

3.1.2.8 execution context: Information maintained by a target for active ORBs so that data transfer may be resumed after a task set abort without loss of data or interruption perceivable to PPDT application clients or services.

3.1.2.9 final ORB: A transport flow ORB whose *final* and *notify* bits are both one. An initiator uses a final ORB to indicate to a target that no subsequent operation request blocks with the same *queue* value will be signaled unless the queue number is reissued by the target in a future CONNECT control request or response.

3.1.2.10 initiator: A node that originates SBP-2 management requests, control and transport flow ORBs and signals them to a target for processing.

3.1.2.11 logical unit: The part of a target's unit architecture that provides access to one or more services. Targets compliant with this standard implement one logical unit with a LUN of zero.

3.1.2.12 login: The process by which an initiator obtains access to a target fetch agent. The target fetch agent and its CSRs provide a mechanism for an initiator to signal ORBs to the target.

3.1.2.13 logout: The process that permits an initiator to relinquish its use of a target fetch agent and all the resources associated with the login.

3.1.2.14 management service: A service automatically provided by a peer unit to execute control requests that establish or terminate connections to other services of the peer unit. The connection to this service is implicitly established as the result of an SBP-2 login.

3.1.2.15 node: An addressable device attached to Serial Bus.

3.1.2.16 nonblocking connection: A bi-directional connection that utilizes two queues for data transfer to and from a target, one for each direction. Since the execution of transport flow ORBs in each queue is unordered with respect to the other, it is not possible for an uncompleted ORB in one queue to block execution of an ORB in the other so long as at least one of the connection's task slots is reserved for the sole use of each queue.

3.1.2.17 octlet: Eight bytes, or 64 bits, of data.

3.1.2.18 operation request block: A data structure fetched from system memory by a target in order to execute the request encapsulated within it.

3.1.2.19 peer unit: A unit compliant with the requirements of this standard, either as an initiator or target. A device may implement both initiator and target unit architectures.

3.1.2.20 quadlet: Four bytes, or 32 bits, of data.

3.1.2.21 queue: An ordered set of operation request blocks within a task set that does not block with respect to other queues that are part of the same task set.

3.1.2.22 receive: When any form of this verb is used in the context of Serial Bus primary packets, it indicates that the packet is made available to the transaction or application layers, *i.e.*, layers above the link layer. Neither a packet repeated by the PHY nor a packet examined by the link is "received" by the node unless the preceding is also true.

3.1.2.23 register: A term used to describe quadlet-aligned addresses that may be read or written by Serial Bus transactions. In the context of this standard, the use of the term register does not imply a specific hardware implementation. For example, in the case of split transactions that permit sufficient time between the request and response subactions, the behavior of the register may be emulated by a processor.

3.1.2.24 request subaction: A packet transmitted by a node (the requester) that communicates a transaction code and optional data to another node (the responder) or nodes.

3.1.2.25 response subaction: A packet transmitted by a node (the responder) that communicates a response code and optional data to another node (the requester). A response subaction may consist of either an acknowledge packet or a response packet.

3.1.2.26 service: A protocol used to control an independently operable component of a peer unit.

3.1.2.27 service data unit: A set of data whose semantics are preserved when transferred between peers at the application layer (clients and services); it is not interpreted by the supporting transport layer (PPDT).

3.1.2.28 split transaction: A transaction that consists of a request subaction followed by a separate response subaction. Subactions are considered separate if ownership of the bus is relinquished between the two.

3.1.2.29 status block: A data structure that may be written to an initiator's *status_FIFO* by a target when an operation request block has been completed.

3.1.2.30 store: When any form of this verb is used in the context of data transferred by the target to the system memory of either an initiator or other device, it indicates both the use of Serial Bus write request subaction(s), quadlet or block, to place the data in system memory and the corresponding response subaction(s) that complete the write(s).

3.1.2.31 system memory: The portions of any node's memory that are directly addressable by a Serial Bus address and which accepts, at a minimum, quadlet read and write access. Computers are the most common example of nodes that might make system memory addressable from Serial Bus, but any node, including those usually thought of as peripheral devices, may have system memory.

3.1.2.32 target: A node that fetches SBP-2 management requests, control and transport flow ORBs from an initiator. A CSR Architecture unit is synonymous with a target.

3.1.2.33 task: A task is an organizing concept that represents the work to be done by a target to carry out a command encapsulated by an ORB. In order to perform a task, a target maintains context information for the task, which includes (but is not limited to) the command, parameters such as data transfer addresses and lengths, completion status and ordering relationships to other tasks. A task has a lifetime, which commences when the task is entered into the target's task set, proceeds through a period of execution by the target and finishes either when completion status is stored at the initiator or when completion may be deduced from other information. While a task is active, it makes use of both target resources and initiator resources.

3.1.2.34 task set: A group of tasks available for execution by a logical unit of a target. ANSI NCITS 325-1998 specifies some dependencies between individual tasks within the task set and this standard mandates others.

3.1.2.35 transaction: A Serial Bus request subaction and the corresponding response subaction. The request subaction transmits a transaction code (such as quadlet read, block write or lock); some request subactions include data as well as transaction codes. The response subaction is null for transactions with broadcast destination addresses or broadcast transaction codes; otherwise it returns completion status and possibly data.

3.1.2.36 unit: A component of a Serial Bus node that provides processing, memory, I/O or some other functionality. Once the node is initialized, the unit provides a CSR interface that is typically accessed by device driver software. A node may have multiple units, which normally operate independently of each other.

3.1.2.37 unit architecture: The specification of the interface to and the services provided by a unit implemented within a Serial Bus node. This standard extends the unit architecture defined by ANSI NCITS 325-1998 to include mechanisms for peer-to-peer data transport.

3.1.2.38 unit attention: A state that a logical unit maintains while it has unsolicited status information to report to one or more logged-in initiators. A unit attention condition shall be created as described elsewhere in this standard or in the applicable command set- and device-dependent documents. A unit attention condition shall persist for a logged-in initiator until a) unsolicited status that reports the unit attention condition is successfully stored at the initiator or b) the initiator's login becomes invalid or is released. Logical units may queue unit attention conditions; after the first unit attention condition is cleared, another unit attention condition may exist.

3.1.2.39 unsolicited status block: A status block whose *src* field is two; the meaning of the *ORB_offset_hi* and *ORB_offset_lo* fields is unspecified and the status block does not pertain to any particular ORB.

3.1.2.40 working set: The part of a task set that has been fetched from the initiator by the target and is available to the target in its local storage.

3.1.3 Abbreviations

The following are abbreviations that are used in this standard:

CSR	Control and status register
CRC	Cyclical redundancy checksum
EUI-64	Extended Unique Identifier, 64-bits
LUN	Logical unit number
ORB	Operation request block
SDU	Service data unit
SBP-2	ANSI NCITS 325-1998

3.2 Notation

The following conventions should be understood by the reader in order to comprehend this standard.

3.2.1 Numeric values

Decimal and hexadecimal numbers are used within this standard. By editorial convention, decimal numbers are most frequently used to represent quantities or counts. Addresses are uniformly represented by hexadecimal numbers, which are also used when the value represented has an underlying structure that is more apparent in a hexadecimal format than in a decimal format.

Decimal numbers are represented by Arabic numerals without subscripts or by their English names. Hexadecimal numbers are represented by digits from the character set 0 – 9 and A – F followed by the subscript 16. When the subscript is unnecessary to disambiguate the base of the number it may be omitted. For the sake of legibility, hexadecimal numbers are separated into groups of four digits separated by spaces.

As an example, 42 and 2A₁₆ both represent the same numeric value.

3.2.2 Bit, byte and quadlet ordering

Devices compliant with this standard use the facilities of Serial Bus, IEEE Std 1394-1995; therefore this standard uses the ordering conventions of Serial Bus in the representation of data structures. In order to promote interoperability with memory buses that may have different ordering conventions, this standard defines the order and significance of bits within bytes, bytes within quadlets and quadlets within octlets in terms of their relative position (from the perspective of Serial Bus) and not their physically addressed position (from the viewpoint of the node's memory bus).

Within a byte, the most significant bit, *msb*, is that which is transmitted first and the least significant bit, *lsb*, is that which is transmitted last on Serial Bus, as illustrated below. The significance of the interior bits uniformly decreases in progression from *msb* to *lsb*.

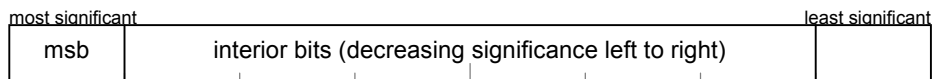

Figure 1 – Bit ordering within a byte

Within a quadlet, the most significant byte is that which is transmitted first and the least significant byte is that which is transmitted last on Serial Bus, as shown below.

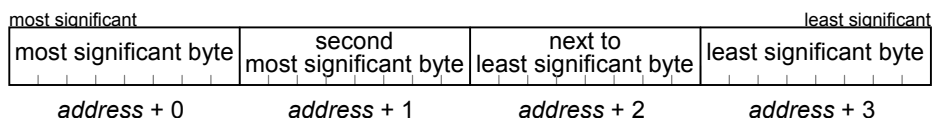

Figure 2 – Byte ordering within a quadlet

Within an octlet, which is frequently used to contain 64-bit Serial Bus addresses, the most significant quadlet is that which is transmitted first and the least significant quadlet is that which is transmitted last on Serial Bus, as the figure below indicates.

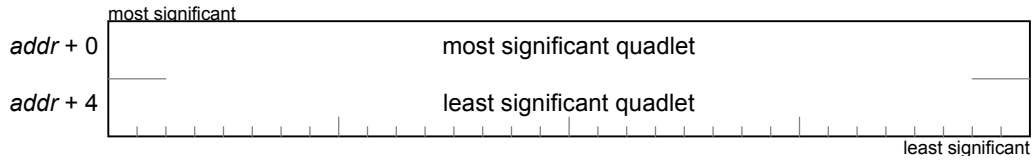

Figure 3 – Quadlet ordering within an octlet

When block transfers take place that are not quadlet aligned or not an integral number of quadlets. No assumptions can be made about the ordering (significance within a quadlet) of bytes at the unaligned beginning or fractional quadlet end of such a block transfer, unless an application has knowledge (outside of the scope of this standard) of the ordering conventions of the other bus.

4 Model (informative)

This section is informative and describes devices that conform to this document and its normative references. It is intended to enhance the usefulness of the other, normative parts of the document. In addition to the information in this clause, users of this document should also be familiar with the CSR architecture, Serial Bus standards and SBP-2.

Examples of devices that come within the scope of this document include (but are not limited to) copiers, printers, facsimile machines, scanners and multifunction peripherals (MFPs) that combine two or more of these capabilities. These devices are characterized by high-volume transfers of application data; modest amounts of control information may be communicated in parallel with the application data transfers. These devices are used with diverse operating systems and application protocols; consequently any standard for their use with Serial Bus needs to hide many of the transport protocol details from the user applications. For example, a print driver that supports Postscript data formats should not be concerned with how data and control information are transported between it and the printer. This document resolves those concerns.

4.1 Protocol stack and service model

The relationship between the initiator and target may be modeled as a software stack present in both devices, as shown by Figure 4 and Figure 5 below. The physical interconnection, *via* Serial Bus, exists at the lowest protocol level. Logical connections (shown by dashed lines) exist at the other protocol levels: an SBP-2 login between the initiator and target multiplexes *queues* (defined by this document) that in turn support end-to-end *connections* (also defined by this document) between client applications and services. This document defines the data structures and methods necessary to implement the shaded levels in the protocol stacks, a peer-to-peer data transport (PPDT) based upon SBP-2. Note that client application(s) may reside at either the initiator or the target (they are commonly found at the initiator) and the service(s) at the complementary SBP-2 functional role, target or initiator.

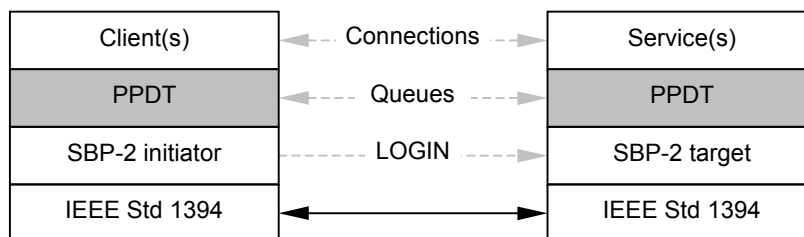

Figure 4 – Protocol stack (service at target)

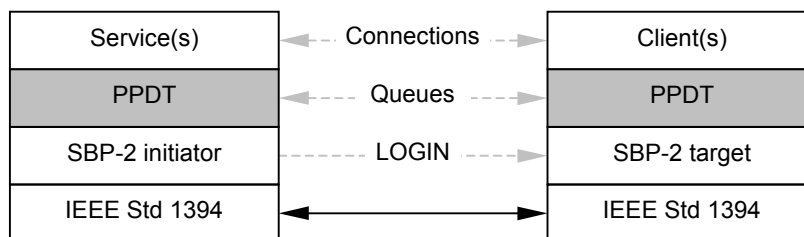

Figure 5 – Protocol stack (service at initiator)

In order for the application(s) and service(s) to communicate in a peer-to-peer, transport-independent manner, this document defines how SBP-2 may be used to implement uni- and bi-directional transport

flows for both control information and application data. Key concepts introduced below are used to explain the details of the transport flow model:

peer unit: A unit compliant with the requirements of this standard, either as an initiator or target. A device may implement both initiator and target unit architectures.

service: A protocol used to control an independently operable component of a peer unit;

management service: A service automatically provided by a peer unit to execute control requests that establish or terminate connections to the other services of the peer unit. The connection to this service is implicitly established as the result of an SBP-2 login;

queue: An ordered set of ORBs within a task set that does not block with respect to other queues that are part of the same task set; and

connection: A queue or a pair of queues that affords access to a service. A connection may be unidirectional or bi-directional; in the latter case, a connection may be blocking or nonblocking. Two queues are necessary to implement a bi-directional, nonblocking connection.

4.2 Independent data paths for each service

ANSI NCITS 325-1998 describes all the work to be performed by a particular logical unit as a *task set*, a collection of ORBs linked together as shown by Figure 6.

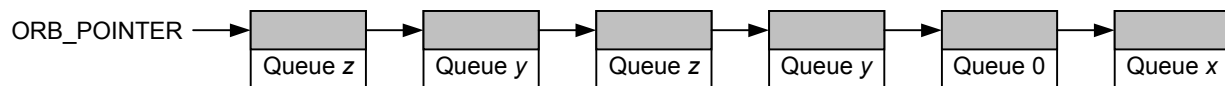

Figure 6 – Multiplexed queues in an SBP-2 task set

Because a single peer unit may implement one or more **services** (protocols used to control independently operable components of a peer unit), each of which may require an independent uni- or bi-directional transport flow, this document augments SBP-2 to permit multiplexed **queues** within a single task set, as illustrated by Figure 7. A queue is a logical construct within a task set; each ORB in the task set is labeled to identify the logical queue to which it belongs. Queues operate independently of each other. Although the target may in general reorder the execution of ORBs within the task set, all of the ORBs within a particular queue are executed in order. Within this framework, both the initiator and the target manage the single task set illustrated above as the collection of logically independent queues illustrated below. The dashed lines connecting ORBs represent the logical ordering of ORBs within each queue, not the actual pointers that link ORBs in the task set.

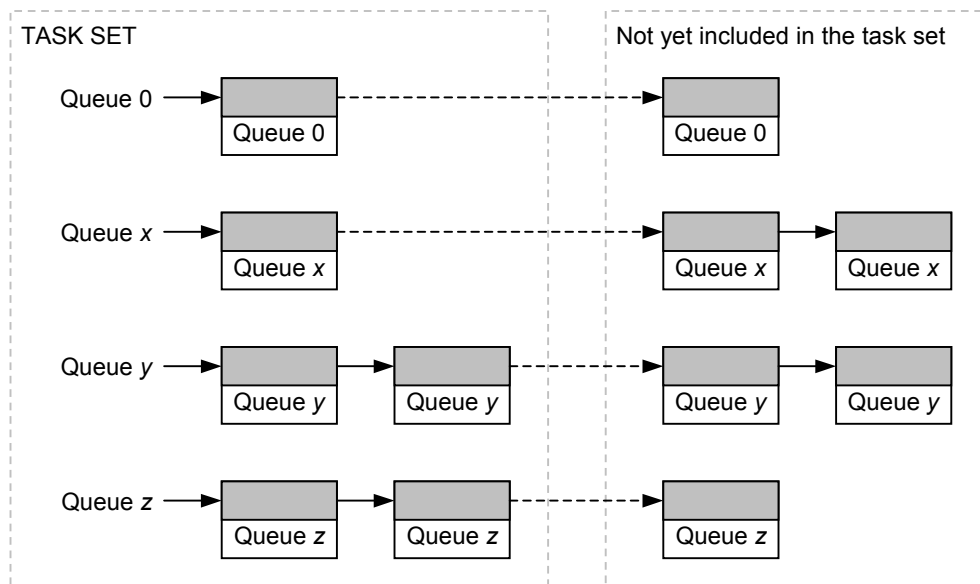

Figure 7 – Independent queues (logical model)

In theory the size of an SBP-2 task set is bounded only by the amount of memory available to the initiator to store ORBs; in practice targets have sufficient memory to fetch only a subset of the task set, the working set. Nonblocking behavior between the separate queues is achieved by restricting the size of the task set to that of the target's working set. If the initiator never places more ORBs in the task set than the target can accommodate in its working set, all outstanding ORBs may be fetched by the target and made available for execution. The initiator restricts the number of outstanding ORBs on a queue by queue basis so that a task slot in the working set is always available for each queue. Since the client application or service may initiate more data transfer requests than can be simultaneously active in the task set, the initiator marshals ORBs by queue number outside of the task set and enters them into the task set as task slots become available.

Because queues do not block with respect to each other, nonblocking bi-directional data transfer between initiator and target may be accomplished through the use of two queues, one for each direction.

4.3 Connection management

The multiplexed queue management scheme just described requires the allocation of target resources (queue numbers and task slots) before it may be used. Collectively these resources constitute a *connection* between a client and a service. This document defines methods by which connection(s) are established and subsequently terminated and their resources freed.

Connections may be established by either an initiator or a target. Because of asymmetries in SBP-2, the connection parameters differ dependent upon the source of the connection request—but at the transport-independent level perceived by clients and services the connection mechanisms are peer-to-peer and symmetric. When a client wishes to establish a connection with a particular service in the other device, it provides a *service ID*, a unique string that specifies the desired service. Service IDs are maintained in a separate registry and are assumed by this document to be well-known identifiers. If the specified service exists in the other device (along with sufficient resources for the connection), the connection is created and subsequently identified by the queue number(s) assigned to the connection.

Connections may be one of three different types:

- Unidirectional; the application data flow is one direction, either from the initiator to the target or *vice versa*;
- Bi-directional (nonblocking); the application data flows in both directions with one queue used for each of the directions; or
- Bi-directional (blocking); the data flows in both directions *via* a single queue which has the potential to block. Nonblocking behavior is not guaranteed by the transport but must be a property of the application itself. The queue used by the management service is an example of a bi-directional, blocking queue, but because both initiator and target restrict their usage such that only one request is outstanding until its corresponding response is transferred, the queue cannot block.

Once a connection is established it persists across bus reset(s) until explicitly terminated or abandoned as a consequence of a logout.

Just as either initiator or target may establish a connection, either may terminate the connection regardless of which one created the connection. A disconnect may be synchronized with the transport flow in order to gracefully end the connection or it may preempt the transport flow if necessary. Once the disconnect is complete, the target resources (queue numbers and task slots) are available for reuse.

4.4 Data transfer between initiator and target

Once a connection is established, application data may be transferred between initiator and target. SBP-2 transport flow ORBs are used to regulate the data transfer: each ORB specifies the direction (from the target or to the target) and provides a buffer that is either the source or destination for the data. The target initiates all data transfer requests, which permits it to pace the data transfer rate according to the availability of its own resources. The initiator, on the other hand, makes all of the data (or a buffer to accommodate all of the data) accessible the whole time the ORB is active.

Data transfer from the initiator to the target is straightforward: the initiator signals an ORB with the appropriate *direction* bit to the target and the target issues read requests to access the data. Data transfer in the opposite direction, from the target to the initiator, is more complex. Because the target may not signal an ORB to the initiator, it indicates to the initiator that data is available. Unless the initiator had anticipated data transfer from the target and already signaled an ORB, the initiator signals an ORB with an empty buffer to receive the data and the target issues write requests to store the data.

In both cases, ORB completion is indicated when the target stores a status block at the initiator. The status block specifies a residual count that indicates the quantity of data transferred. The status block also includes codes that describe successful or error completion of the data transfer described by the ORB. The status block does not indicate whether or not the data was successfully utilized by an application client or service—only whether or not the data was transferred across Serial Bus.

Data transfer between initiator and target is modeled either as a datagram or as a stream. When datagram mode is used, each service data unit (SDU) fits within a single buffer described by an ORB. If no SDU is available for transfer, the ORB may block and not be completed until an entire SDU is ready. Or, if the recipient is unable to accept the SDU (too small a buffer), no data is transferred and an error results. In contrast, stream mode permits data to flow as it becomes available. An ORB that transfers data to a target in stream mode cannot fail because the target's buffer is too small while an ORB that transfers stream data from a target may complete as soon as the first byte of data is available.² In both cases, datagram and stream, circumstances may arise where ORBs are completed even though no data has been transferred.

² Applications may defer completion of an ORB until some minimum amount of data has been transferred. This "watermark" capability may improve performance.

4.5 Control requests and responses

In order to coordinate the flow of application data between initiator and target, a set of control operations are defined. These operations take the form of a control request and a corresponding response; their functions include establishment of a connection, notification that target data is available for transfer to the initiator and confirmed release of queue resources upon disconnection. Either initiator or target may originate a control request; neither may initiate a subsequent control request until a control response is returned for an outstanding request.

Control requests and responses are not encoded within ORBs themselves but are contained within data transferred between initiator and target buffers. ORBs that mediate the transfer of control information are no different from those used for application data except that they specify predefined queue zero. This bi-directional, blocking queue is reserved solely for control requests and responses and is not available for the transfer of application data between initiator and target. Queue zero (the control queue) is automatically allocated as a result of successful login and may not be released by either initiator or target until logout.

The operational sequences for queue zero differ dependent upon the originator of the control request, initiator or target, as illustrated below.

When the initiator originates a control request, it signals an ORB to the target that describes a buffer that contains the control request. The initiator subsequently signals another ORB to the target that describes a buffer available to receive the response. For the sake of efficiency, both ORBs may be linked and signaled to the target at the same time as illustrated by Figure 8.

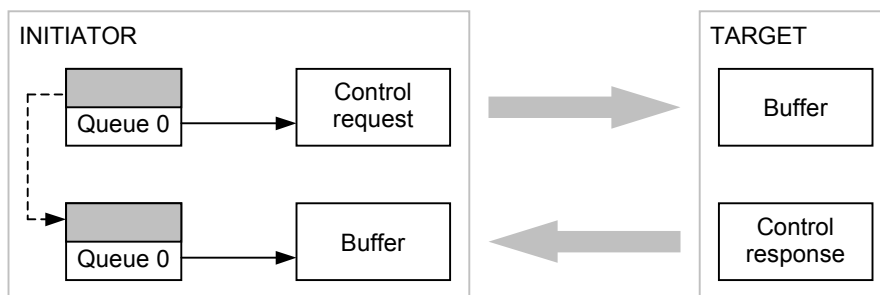

Figure 8 – Control request originated by initiator

In the figure above, the target fetches the control request from the initiator's buffer and then stores completion status at the initiator's *status_FIFO*. The control request itself is not necessarily executed at this point but it has been securely read by the target. After the request is executed, the target stores a control response in the buffer provided by the second ORB and then stores completion status for that ORB at the initiators *status_FIFO*. Successful receipt of the control response permits the initiator to examine the response data to determine whether or not the request succeeded.

In the case where the target has a control request to make of the initiator, it first communicates to the initiator that a queue zero ORB is needed. This attention condition may be communicated by any status block, either one associated with the completion of application data transfer on a queue other than queue zero, a status block for a completed queue zero transfer or an unsolicited status transfer. The result is the same no matter what the source of the status block; this is illustrated by the upper portion of Figure 9.

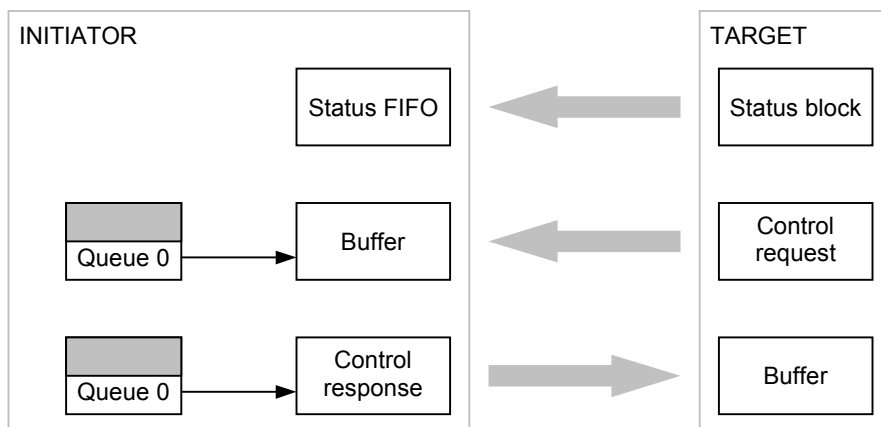

Figure 9 – Control request originated by target

In response to a status block that indicates an attention condition, the initiator signals an ORB to the target that describes a buffer available to receive the control request. Note that the initiator cannot signal an ORB for the response at the same time because the control response is not yet available. Once the target has transferred the control request to the initiator buffer, it stores completion status for the ORB at the initiator *status_FIFO*. Receipt of this status block permits the initiator to retrieve the control request, process it, prepare a control response and signal an ORB to the target that describes a buffer that contains the control response. After the target has read the control response, it stores completion status at the initiator *status_FIFO*.

When control requests are simultaneously available at both initiator and target, the order in which they are processed is arbitrary so long as request execution is not concurrent. An initiator may not originate a subsequent request if it detects a target attention condition during the current control request and response cycle.

4.6 Unsolicited status

As described above, a target communicates an attention condition to an initiator when the target has control request or response information available. An attention condition often exists or arises synchronously with the completion of a transport flow ORB, in which case it is indicated by the *attention* bit in the status block for that ORB. At other times, the occurrence of an attention condition is asynchronous (for example, when the target generates autonomous response information). In this case, the target may store an unsolicited status block at the initiator *status_FIFO*.

The essential nature of an unsolicited status block is that it is not associated with any ORB. As a consequence, it is useful only for information that is generic to the target (such as the attention condition) and useless to communicate more specific information (such as the state of a particular queue).

4.7 Reverse login and logout

The preceding clauses describe peer-to-peer operations between an initiator and a target once the target has granted a login requested by the initiator. This is the natural SBP-2 model and corresponds to the common situation where the client application (e.g., a device driver) is located at the initiator and the service is located at the target. When the situation is reversed and the target is the one to initiate operations, there is no corresponding SBP-2 login request from the target to the initiator.

This standard defines a new facility, "reverse login", which permits a target to request an initiator to perform an SBP-2 login. The method is based on the MESSAGE_REQUEST register defined by draft standard IEEE P1212.

Just as there is a need for reverse login, there are also times when the target has no more use for a login and wishes the initiator to logout. Since a login already exists between initiator and target, there is no need to use the MESSAGE_REQUEST register. Instead, this standard defines a “reverse logout” facility that uses the management service to signal the initiator to perform an SBP-2 logout.

5 Data structures

This document defines the format of those parts of the SBP-2 ORB and status block reserved by ANSI NCITS 325-1998 for specification by command set standards. It also defines a format for control information transferred between initiator and target and a message structure used for reverse login from a target to an initiator. All data structures defined in the following clauses shall be aligned on quadlet boundaries.

5.1 Transport flow ORBs

ANSI NCITS 325-1998 defines command block ORBs for SBP-2 devices; these have a common 20-byte header and leave the definition of the subsequent quadlets to individual command set standards. Devices compliant with this standard shall use 32-byte command block ORBs (renamed transport flow ORBs to emphasize their function) whose format is illustrated by Figure 10. Transport flow ORBs are used to regulate the transfer of application data or control information between initiator and target.

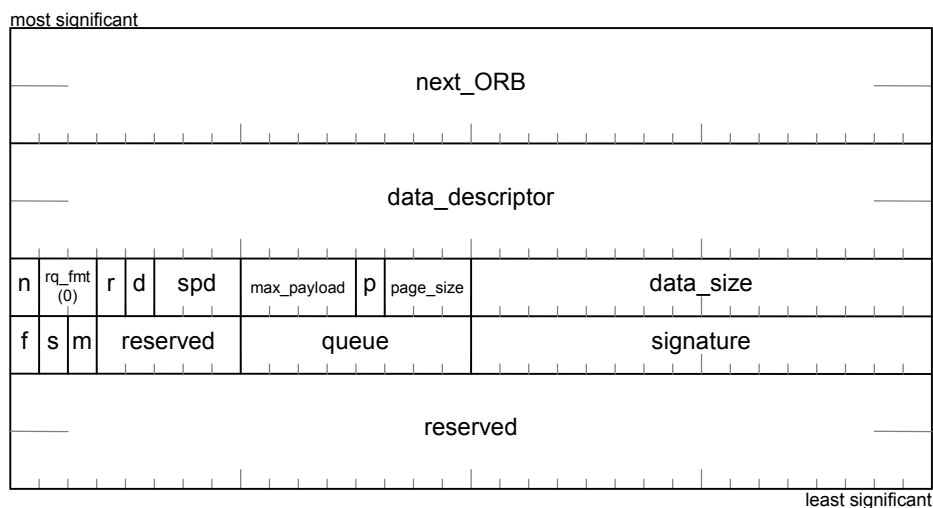

Figure 10 – Transport flow ORB

The usage of the *next_ORB*, *data_descriptor*, *rq_fmt*, *spd*, *max_payload*, *page_size* and *data_size* fields and the *notify* and *page_table_present* bits (abbreviated as *n* and *p*, respectively, in the figure above) is defined by ANSI NCITS 325-1998. The *rq_fmt* field shall be zero.

NOTE – For most PPDT implementations the *notify* bit should always be one so that the SBP-2 initiator software may accurately determine completion status for each ORB; this is a consequence of the unordered execution model. Other implementations that do not require completion status notification for each ORB may be possible but the details are beyond the scope of this document.

The *direction* bit (abbreviated as *d* in the figure above) shall specify the direction of data transfer for the buffer. If the *direction* bit is zero, the target shall use Serial Bus read transactions to fetch data from the buffer (the flow direction is from the initiator to the target). Otherwise, when the *direction* bit is one, the target shall use Serial Bus write transactions to store data in the buffer (the flow direction is from the target to the initiator).

NOTE – The direction of data transfer is determined solely by the *direction* bit without reference to the *queue* number. Unspecified behavior may occur if an ORB's *direction* bit does not match the expected data transfer direction for the queue.

The *final* bit (abbreviated as *f* in the figure above) shall be set to one to indicate that the initiator shall not signal any subsequent ORBs with the same *queue* value as this ORB until the target allocates the queue number in a future CONNECT request or response. Otherwise the value of *final* bit shall be zero and the initiator may continue to signal ORBs for the queue. When the *final* bit is one the *notify* bit shall also be one.

The *special* bit (abbreviated as *s* in the figure above) provides additional information pertinent to application data transferred from the initiator to the target. The meaning of the *special* bit is unspecified when either of the *data_size* or *queue* fields are zero or the *direction* bit is one. Otherwise the meaning and usage of the *special* bit are application-dependent and shall apply to all of the application data contained within the buffer described by the ORB.

NOTE – Stream socket abstractions include the notion of *out of band* data, as some transport protocols allow portions of incoming data to be marked as "special" in some way. These special data blocks may be delivered to the user out of the normal sequence—for example, expedited data in X.25 and other OSI protocols or the use of urgent data in TCP by BSD Unix. The *special* bit enables such usage to be mapped to PPDT.

The *end_of_message* bit (abbreviated as *m* in the figure above) shall indicate whether or not a boundary exists in the application data or control information transferred from the initiator to the target. The meaning of the *end_of_message* bit is unspecified when the *direction* bit is one. Otherwise, when *end_of_message* is one, a boundary exists after the last byte of application data or control information described by the ORB. In the case of application data, the nature of the boundary and its interpretation shall be specified by the service definition. When the *queue* field is zero, the *end_of_message* bit shall also be one; all control information for a single request or response shall be contained within one buffer.

NOTE – When *end_of_message* is one and *data_size* is zero, a boundary exists at the end of application data or control information previously transferred to the target. The target flushes this data to the receiving application client and indicates the *end_of_message* condition.

The *queue* field shall specify either a queue number assigned by the target in either a CONNECT request or response (see 6.3.1) or queue zero. When the *queue* field is zero, the *final* bit shall be zero and the *notify* bit shall be one.

The *signature* field shall contain an identifying number assigned by the initiator and shall be unique within the context of a queue. Individual data buffers are uniquely identified by the combination of *queue* and *signature*. For a particular queue, an initiator shall not reuse a *signature* value until either the queue has been shutdown (see 6.3.2) or a status block has been received for a subsequent ORB in the same queue. This field is used to facilitate the resumption of data transfer after a bus reset or other transient interruption while minimizing retransmission of data securely stored prior to the interruption (see 7.5).

5.2 Status block

As described by ANSI NCITS 325-1998, a target may store status at an initiator *status_FIFO* address when a transport flow ORB completes (successfully or in error) or because of an unsolicited event (device status change). Whenever the target has status to report and is enabled to do so, it shall store the status block illustrated by Figure 11.

Without regard to the value of the *notify* bit in the ORB to which status pertains, the target shall store completion status if any of the *dead*, *attention*, *target_data_pending*, *special* and *end_of_message* bits or either of the *status* and *residual* fields are nonzero.

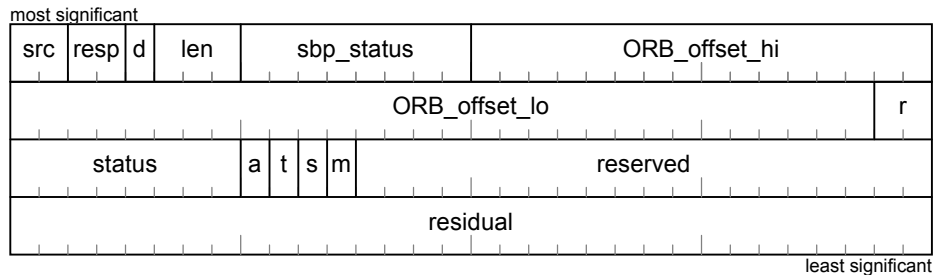

Figure 11 – Status block format

The first two quadlets of the status block are specified by ANSI NCITS 325-1998 and are therefore common to all PPDT devices. The definition and usage of the *src*, *resp*, *len*, *sbp_status*, *ORB_offset_hi* and *ORB_offset_lo* fields, as well as the *dead* bit (abbreviated as *d* in the figure above), are specified by ANSI NCITS 325-1998.

The *len* field shall have a value of three to indicate that the length of the status block is four quadlets.

When *resp* and *sbp_status* are zero, the *status* field shall specify the completion status of the transport flow requested by the ORB, as encoded by the table below.

<i>status</i>	Description
0	The application data or control information has been successfully transferred; consult the <i>residual</i> field for details of the actual transfer length.
1	Invalid queue; the queue identified in the ORB is not allocated to an active connection.
2	Target reset by another initiator; all tasks aborted.
3	Abortive queue shutdown requested by target; no application data has been transferred.

The *attention* bit (abbreviated as *a* in the figure above) indicates the availability of target control information. When the *attention* bit is one, the initiator should signal an ORB for queue zero to retrieve the control information. Once set to one by the target, this bit shall remain set in subsequent status blocks until the target successfully stores the control information in an initiator buffer.

The *target_data_pending* bit (abbreviated as *t* in the figure above) indicates the availability of target application data for the queue specified by the ORB identified by *ORB_offset_hi* and *ORB_offset_lo*. When the *target_data_pending* bit is one, the initiator should signal an ORB for the specified queue to retrieve the application data. The target shall zero this bit when there is no pending application data awaiting transfer to the initiator. The meaning of *target_data_pending* is unspecified for an unsolicited status block.

The *special* bit (abbreviated as *s* in the figure above) provides additional information pertinent to application data transferred from the target to the initiator. The meaning of the *special* bit is unspecified for an unsolicited status block, if no data has been transferred, or when (in the ORB identified by *ORB_offset_hi* and *ORB_offset_lo*) any of the *data_size* or *queue* fields or the *direction* bit are zero. The meaning and usage of the *special* bit are application-dependent and shall apply to all of the application data contained within the buffer described by the ORB.

The *end_of_message* bit (abbreviated as *m* in the figure above) shall indicate whether or not a boundary exists in the application data or control information transferred from the target to the initiator. The meaning of the *end_of_message* bit is unspecified for an unsolicited status block or when the *direction* bit (in the

ORB identified by *ORB_offset_hi* and *ORB_offset_lo*) is zero. Otherwise, when *end_of_message* is one, a boundary exists after the last byte of application data or control information described by the ORB. In the case of application data, the nature of the boundary and its interpretation shall be specified by the service definition. When the *queue* field (in the ORB identified by *ORB_offset_hi* and *ORB_offset_lo*) is zero, the *end_of_message* bit in the associated status block shall also be one; all control information for a single request or response shall be contained within one buffer.

When *status* is zero, the *residual* field shall specify the difference between the requested and actual data transfer lengths, in bytes. The meaning of *residual* field is unspecified for an unsolicited status block.

When *residual* is negative, no data has been transferred because of a mismatch between the size of the buffer and the data transfer length acceptable to the target: either the target's buffer space is too small to accept the data described by the ORB to which the completion status pertains or else the buffer described by the pertinent ORB is too small to accept the data available from the target. In these cases, the meaning of *residual* depends upon the value of the *direction* bit of the ORB to which the completion status pertains. When *direction* is zero (the flow direction is from the initiator to the target), the target shall calculate *residual* by subtracting the size of the buffer provided by the initiator from the maximum acceptable data transfer length. Otherwise, when *direction* is one (the flow direction is from the target to the initiator), the target shall calculate *residual* by subtracting the minimum acceptable data transfer length from the size of the buffer provided by the initiator. Negative values shall be encoded in two's complement notation.

Otherwise, when *residual* is greater than or equal to zero, there is no mismatch between the size of the buffer and the data transfer length to prevent data transfer. The target shall calculate *residual* by subtracting the actual data transfer length from the size of the buffer provided by the initiator. A *residual* value greater than zero is not necessarily indicative of an error.

NOTE – Specifications for the use of the *residual* field are provided in 7.1 and 7.2.

5.3 Control information

Control information, both requests and their corresponding responses, may be exchanged between initiator and target *via* transport flow ORBs whose *queue* field is zero (control ORBs). This indicates that the data in the buffer (or the data to be stored in the buffer) associated with the ORB is control information rather than application data. Only one control request or response shall be transferred by an ORB; when the *direction* bit is zero the *end_of_message* bit in the ORB shall be one, otherwise the *end_of_message* bit in the status block shall be one. If the initiator has provided more control information than the target can accept or if the buffer is too small to receive all the target's control information, no transfer shall take place and the *residual* field shall indicate the appropriate transfer size (see 0 and 0). The format of the control information in the buffer is illustrated by Figure 12.

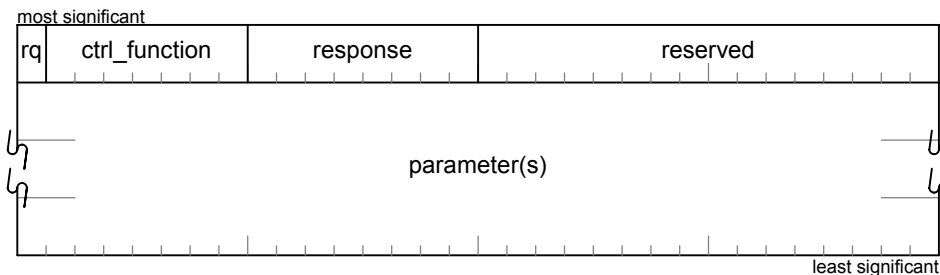

Figure 12 – Control information format

The *rq* bit shall specify whether the control information contains a request or a response. A value of one indicates a request.

The *ctrl_function* field shall specify the control function, as defined by the table below.

<i>ctrl_function</i>	Name	Comment
0		Reserved for future standardization
1	CONNECT	Establish a connection with a particular service
2	SHUTDOWN QUEUE	Initiate the release of resources for a queue that will no longer be used
3	RELEASE QUEUE	After a queue is shutdown, confirm that resources may be safely released
4	STATUS	Query the availability of target data for queues other than the control queue
5	REVERSE LOGOUT	The target no longer requires a login from the initiator; the initiator should logout as soon as possible.
6 – 7F ₁₆		Reserved for future standardization

The *response* field is valid only when the *rq* bit is zero. In this case, it encodes a response indication for the corresponding control function, as defined by the table below.

<i>response</i>	Definition
0	Request completed OK; response parameters are meaningful.
1	Unknown control function.
2	Insufficient resources are available to complete the request; the same request may succeed if resubmitted later.
3	The service identified by the SERVICE_ID parameter does not exist.
4	Mismatch between the queue parameter(s) provided in a CONNECT request and those expected by the service.
5	The connection request is refused.
FF ₁₆	Unspecified error.

The remainder of the control information shall consist of zero or more parameters identified by a parameter ID (see Table 1). Relative to the start of the buffer, each parameter shall be quadlet-aligned and occupy an integral number of quadlets. The first parameter shall start in the second quadlet of control information and subsequent parameters, if any, shall immediately follow the preceding parameter. The order in which parameters appear is unimportant. Either the parameters shall completely fill the control information or they shall be followed by a zero quadlet.

Table 1 – Parameter ID values

Parameter ID	Parameter Name	Value restrictions	Description
0		0	Indicates end of parameter list in control information (optional).
1	TASK_SLOTS	Minimum 1 per queue	For a particular connection, the maximum number of ORBs permitted in the task set. The initiator shall observe the limit established by the target and may optionally provide this parameter to indicate a self-imposed limit. Task slots are allocated <i>per</i> connection and may be used for any of the connection's queues.
2	I2T_QUEUE	Nonzero; FF ₁₆ maximum	The queue number assigned to the connection for the transport of application data from the initiator to the target
3	T2I_QUEUE		The queue number assigned to the connection for the transport of application data from the target to the initiator
4	MODE	0, 1	Specifies the desired mode at the time a connection to a service is established. Zero indicates datagram mode; one specifies stream mode.
80 ₁₆	SERVICE_ID	40 bytes maximum	An ASCII text string (without leading or trailing blank characters) that uniquely identifies a service.
81 ₁₆	QUEUE_INFO		A bit map that reports the state of <i>target_data_pending</i> for queues other than the control queue (see Figure 15).

The parameter ID shall specify the parameter format, either immediate or variable-length. The most significant bit of the parameter ID determines the format; parameters whose ID values are in the range zero to 7F₁₆, inclusive, shall conform to the format specified by Figure 13 while those in the range 80₁₆ – FF₁₆, inclusive, shall conform to the format specified by Figure 14. All parameter ID values not specified are reserved for future standardization.

The format of immediate parameters is shown below.

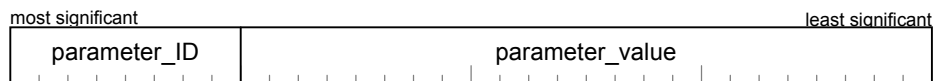

Figure 13 – Immediate parameter format

The *parameter_ID* field shall specify the parameter, as encoded by Table 1.

The *parameter_value* field shall specify the immediate value of the parameter. Unless otherwise specified for a particular value of *parameter_ID*, the *value* field shall contain an unsigned 24-bit number.

The format of variable-length parameters (which are usually ASCII text strings) is shown below.

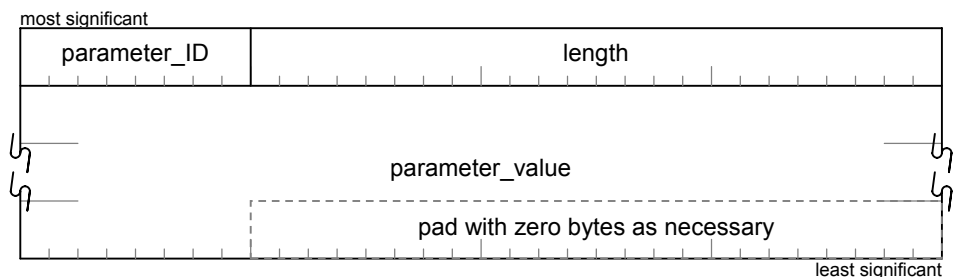

Figure 14 – Variable-length parameter format

The *parameter_ID* field shall specify the parameter, as encoded by Table 1.

The *length* field shall specify the length of the *parameter_value* field, in bytes. Pad bytes, if present, are excluded from the value of *length*.

The *parameter_value* field shall contain the value of the parameter and shall commence with the most significant byte of the parameter value. If the length of the parameter is not a multiple of four, the parameter value shall be padded with trailing bytes of zero.

5.4 Queue information

Queue information is a variable-length parameter that conforms to the format illustrated by Figure 15. Each entry in the array reports status information for a queue implemented by the target. Queue information shall include all active queues but may be truncated to omit inactive queues implemented by the target.

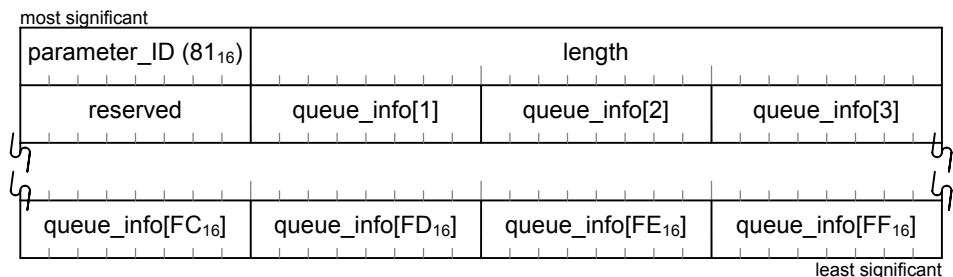

Figure 15 – Queue information format

The value of *parameter_ID* shall be 81₁₆.

The value of *length* shall be nonzero and less than or equal to 256.

Each *queue_info* entry provides information for an individual queue; this array of bytes is directly indexed by the queue number. The first entry in the array is reserved.³ For all other queues, the format of the *queue_info* byte is specified by Figure 16.

³ Queue zero is always active; the availability of control information is indicated by the status block *attention* bit.



Figure 16 – Queue information byte format

The *active* bit shall be zero if the queue is not implemented by the target or not assigned to an established connection. A value of one indicates that the queue is in use by a connection. The status of a queue, active or inactive, is as perceived from the perspective of the target.

The *target_data_pending* bit (abbreviated as *t* in the figure above) indicates the availability of target application data for the queue. When the *target_data_pending* bit is one, the initiator should signal a transport flow ORB for the specified queue to retrieve the application data (unless such an ORB is already active). The target shall zero this bit when there is no pending application data awaiting transfer to the initiator.

5.5 Reverse login request and response

The reverse login facility utilizes a 64-byte block write addressed to an initiator's MESSAGE_REQUEST register or a target's MESSAGE_RESPONSE register. The format of the data payload conforms to draft standard IEEE P1212 and is illustrated by Figure 17.

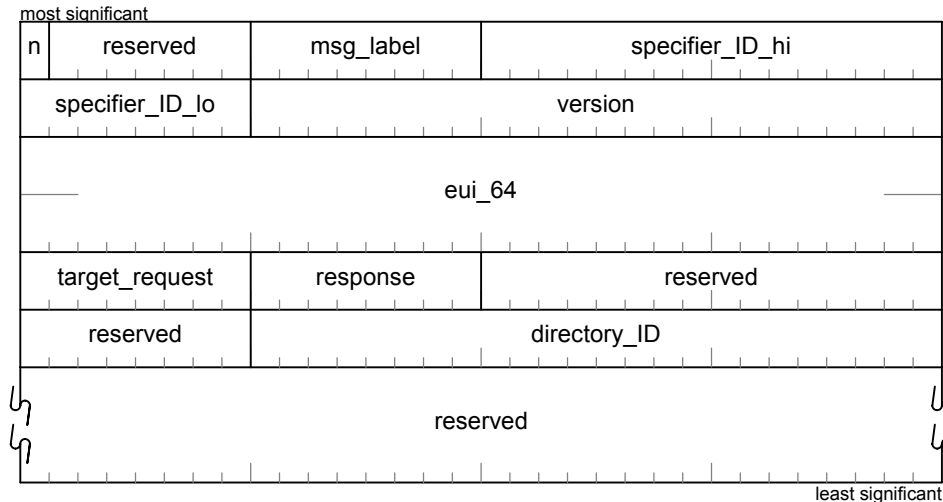

Figure 17 – Reverse login request / response format

In a reverse login request addressed to an initiator's MESSAGE_REQUEST register, the *notify* bit (abbreviated as *n* above) shall be one; the initiator is requested to write a response to the target's MESSAGE_RESPONSE register. In the response returned to the target, *notify* shall be one if the initiator does not implement the reverse login facility; otherwise it shall be zero and *response* shall indicate the completion status of the request.

The *msg_label* field shall be zero.

The *specifier_ID* field shall be 00 5029₁₆.

The *version* field shall be zero.

The *eui_64* field shall be equal to the EUI-64 in the target's bus information block. The initiator shall leave this field unchanged when a response is written to the MESSAGE_RESPONSE register.

The *target_request* field shall contain a value specified by the table below; all values not explicitly defined are reserved for future standardization.

<i>target_request</i>	Name	Comment
0	NOP	No effects at initiator; response indicates whether or not initiator supports reverse login.
1	REVERSE LOGIN	Requests the initiator to login in to the specified node and unit directory.

The *response* field shall be zero in a reverse login request. In the response returned to the target's MESSAGE_RESPONSE register, *response* shall indicate completion status as specified by the following table.

<i>response</i>	Name	Comment
0	OK	The request is acknowledged and the initiator will attempt the requested action.
1	RESOURCES UNAVAILABLE	The initiator cannot attempt a login at present; a subsequent REVERSE LOGIN request by the target may succeed.
FF ₁₆	REJECTED	The request is rejected for unspecified reasons.

The *directory_ID* field shall identify the unit to which the initiator is requested to transmit a LOGIN request. A directory's ID may be specified explicitly by a Directory_ID entry or, absent such an entry, implicitly by the least significant 24 bits of the base address of the directory within node space.

6 Control operations

Before application client(s) and service(s) may exchange data in uni- or bi-directional transport flows (explained in detail in section 7), control operations are necessary to set up the communication paths. This section specifies the methods used by both initiator and target to establish and manage connections for these transport flows.

6.1 Login, reverse login and queue zero

Access to a target compliant with this standard commences with an SBP-2 login request by the initiator. Upon successful completion of the login request, the target has reserved resources for use by the initiator:

- SBP-2 registers assigned by the target at the time of the login (the AGENT_STATE, AGENT_RESET, ORB_POINTER, DOORBELL and UNSOLICITED_STATUS_ENABLE registers);
- queue zero, the control queue; and
- two task slots for use by queue zero ORBs.

In cases where a target wishes to communicate with an initiator but no login exists, a target may use the "reverse login" facility to request an SBP-2 login from the initiator. The target constructs a reverse login message (see 5.5) and stores it at the initiator's MESSAGE_REQUEST register. If the target receives a success response at its own MESSAGE_RESPONSE register, the initiator either has attempted or shall attempt to establish a login. An initiator that initiates SBP-2 login in response to a reverse login request should persist in its attempts until a login response is received from the target.

NOTE – A target should not create a flood of reverse login requests; if no response is received to a reverse login request, the target should wait a reasonable, implementation-dependent time before retransmission of a the request.

Once queue zero exists, either initiator or target may use it in a peer-to-peer fashion to communicate control information, requests or responses, to the other. At no time shall the task set contain more than two control ORBs.

The completion of a request requires two ORBs, one that describes the control information buffer that contains the request and a complementary ORB that describes the control information buffer for the response. Although queue zero provides full peer-to-peer functionality between initiator and target, the details of its use are asymmetric and vary according to whether the initiator or the target is the requester.

When an initiator issues a request to a target, they shall perform the following operations:

- a) The initiator shall store the request and its associated parameters (if any) in a buffer in system memory and signal to the target fetch agent an ORB, whose *queue* field and *direction* bit are zero and *end_of_message* bit is one, that describes the control information buffer;
- b) The target shall fetch the ORB and read the control information buffer. The status block stored by the target to complete the ORB may have its *attention* bit set to one to indicate that the target intends to transfer control information (the response) to the initiator;
- c) At any time the initiator receives a status block whose *attention* bit is one and there is no ORB in the task set whose *queue* field is zero and *direction* bit is one, the initiator shall create such an ORB and place it in the task set; and
- d) Once the target has executed the indicated request and there is an ORB in the working set whose *queue* field is zero and *direction* bit is one, the target shall store the response data in the buffer described by the ORB and then store completion status for the ORB. So long as the target has

pending control information to transfer to the initiator, it shall continue to set the *attention* bit to one in any status block (including unsolicited status) stored into the initiator *status_FIFO*.

NOTE – In order to reduce ORB fetch latency, the initiator may place two control information ORBs in the task set at the same time, the first for the request (with a *direction* bit of zero) and the second for the response (with a *direction* bit of one). Although the algorithm described above works correctly even if the initiator awaits a status block whose *attention* bit is one before signaling a target response ORB to receive the response data, it is more efficient to signal both ORBs at the same time.

When a target issues a request to an initiator, they shall perform the following operations:

- a) The target shall set the *attention* bit to one in a status block stored into the initiator *status_FIFO*. Either unsolicited status or completion status associated with an ORB may be used. So long as the target has pending control information to transfer to the initiator, it shall continue to set the *attention* bit to one in any status block stored into the initiator *status_FIFO*.
- b) At any time the initiator receives a status block whose *attention* bit is one and there is no ORB in the task set whose *queue* field is zero and *direction* bit is one, the initiator shall create such an ORB and place it in the task set;
- c) Once there is an ORB in the working set whose *queue* field is zero and *direction* bit is one, the target shall store the control information data (request) in the buffer described by the ORB and then store completion status for the ORB. The *attention* bit shall be zero in the status block associated with the ORB;
- d) When the initiator has executed the indicated request, it shall store the response and its associated parameters (if any) in a buffer in system memory and signal to the target fetch agent an ORB that describes the control information buffer. The ORB's *queue* field and *direction* bit shall be zero and the *end_of_message* bit shall be one;
- e) The target shall fetch the ORB and read the response from the control information buffer. The status block stored by the target to complete the ORB may have its *attention* bit set to one if the target intends to transfer other control information (request or autonomous response) to the initiator.

It is possible for both initiator and target to initiate requests at roughly the same time. In this case the working set contains an ORB for transfer of the request from initiator to target while the status block *attention* condition is simultaneously asserted by the target. The ordered execution properties of queue zero give a natural precedence to initiator requests over target requests, as follows. When a target fetches an ORB whose *queue* field and *direction* bit are zero and whose *end_of_message* bit is one, the request contained in the control information shall be processed before a request is transferred to the initiator. Consequently, if a target has an uncompleted initiator request when it fetches a control ORB and whose *direction* bit is one it shall not store any control information except the response that completes the request.

When neither initiator nor target have outstanding requests or responses there shall be no ORBs in the task set whose *queue* field is zero.

6.2 Autonomous response information

The preceding clause describes the use of queue zero for request / response pairs between initiator and target. It is also possible for either initiator or target to autonomously transfer response information to the other. Autonomous response information is typically status information and does not necessarily require any additional action on the part of the recipient.

Autonomous response information may be sent for queue status information, identified by a *ctrl_function* value of STATUS.

The *response* code in autonomous response information shall be zero.

Autonomous response information shall not be transferred while there is an uncompleted control request. A target requests the transfer of autonomous response information by means of the status block *attention* bit. If a target asserts *attention* and subsequently fetches an initiator request ORB, it shall first complete the initiator's control request and transfer the corresponding response information to the initiator before transferring the autonomous response information. The *attention* bit shall remain asserted in any status blocked stored in the initiator *status_FIFO* while the transfer of the autonomous response information is pending.

6.3 Connection management

Control ORBs are used to establish and terminate connections that permit the flow of application data between clients and services in either initiators or targets. The control requests are CONNECT, SHUTDOWN QUEUE and RELEASE QUEUE. The connection type is established when the connection is created and is implicitly encoded by the I2T_QUEUE and T2I_QUEUE parameters present in the connection request or response information, as specified by Table 2.

Table 2 – Connection type encoded by queue ID parameters

Connection type	I2T_QUEUE value	T2I_QUEUE value
Unidirectional	unrestricted	—
	—	unrestricted
Bi-directional (nonblocking)	not equal to T2I_QUEUE	not equal to I2T_QUEUE
Bi-directional (blocking)	equal to T2I_QUEUE	equal to I2T_QUEUE

Unidirectional connections are described by a single parameter, I2T_QUEUE or T2I_QUEUE. If both parameters are present, the connection is bi-directional and is either blocking or nonblocking according to whether the two parameter values are equal or different, respectively.

6.3.1 Connection establishment

Before a PPDT client application may communicate with a service, the transport layer shall allocate and confirm necessary resources by means of a control request with a *ctrl_function* code of CONNECT and its corresponding response. The operations are fundamentally similar whether the service resides at the initiator or the target, but because the initiator and target control different resources, the procedures are described separately.

The minimal initiator resource required for a connection is sufficient system memory to hold the ORBs that form the subset of the task set allocated to the connection.

The minimum target resources required for a connection are one or two available queue numbers as well as local memory to hold active ORBs and their associated context (up to the maximum set by the target via the TASK_SLOTS parameter).

With respect to task slots, the initiator shall guarantee that the task set never contains more active ORBs for the connection than the smaller of the TASK_SLOTS value specified by the target or optionally specified by the initiator. It is unimportant whether the CONNECT request was originated by the initiator or target.

Once a successful control response has been received (by either the initiator or target, as appropriate) for a connection request, the initiator may place ORBs into the task set that use the queue number(s)

specified by the target. A queue number remains valid until either a LOGOUT (either explicit on the part of the initiator or implicit as the result of a failure to reconnect after a bus reset) or the queue is shutdown.

6.3.1.1 Connection established by an initiator

When a PPDT application client at an initiator desires to establish a connection with a target service, the initiator shall create a control ORB whose buffer contains a CONNECT control request. The initiator shall specify the SERVICE_ID and MODE parameters. The initiator may specify the TASK_SLOTS parameter.

If the connection is established, the target shall return response data that specifies TASK_SLOTS and one or both of the I2T_QUEUE and the T2I_QUEUE parameters. When the initiator has provided the optional TASK_SLOTS parameter in its request, the target should return a TASK_SLOTS value less than or equal to that specified by the initiator.

6.3.1.2 Connection established by a target

A PPDT application client at a target that desires to establish a connection with an initiator service shall request the target to create control information that contains a CONNECT control request and signal the initiator to retrieve the control information by asserting the *attention* bit in a status block. The CONNECT control request shall specify the SERVICE_ID, MODE, TASK_SLOTS and one or both of the I2T_QUEUE and T2I_QUEUE parameters.

If the requested service exists at the initiator and supports the requested transport flow mode, datagram or stream, the connection may be confirmed by a control response from the initiator. No parameters are required in the control response, but the initiator may specify the TASK_SLOTS parameter.

The initiator shall not use the queue number(s) identified by the I2T_QUEUE or T2I_QUEUE parameters until successful completion status has been stored at the initiator's *status_FIFO* for the ORB that transferred the control response to the target.

6.3.2 Queue shutdown

Although more than one queue may be allocated as the result of a connection request, queues are shutdown individually; there is no unified disconnection request that affects all of a connection's queues. When all queues allocated to a connection are shutdown, the connection no longer exists and all resources allocated to it may be released.

Either the client application or the service may request queue shutdown; there are no fundamental differences. A more important consideration is whether it is the queue's data producer or data consumer that initiates the shutdown. Queue shutdown requested by the producer may be orderly while shutdown requested by the consumer is unlikely to be orderly, as summarized by the table below.

Data transport flow	Queue shutdown requestor	
	Initiator	Target
Initiator to target (I2T_QUEUE)	Orderly	Abortive
Target to initiator (T2I_QUEUE)	Abortive	Orderly
Bi-directional (I2T_QUEUE equals T2I_QUEUE)	Application-dependent	

An orderly shutdown occurs when the consumer is able to successfully receive all the data produced prior to queue shutdown. An abortive shutdown is characterized by the loss of data between the two endpoints. Whether or not the shutdown of a queue used to transfer data in either direction (*i.e.*, a queue used by a bi-directional, blocking connection) is abortive or orderly is dependent upon usage rules agreed by the client application and service and is beyond the scope of this document.

6.3.2.1 Queue shutdown by an initiator

When an application client or service at an initiator desires to shutdown a queue, the initiator shall signal a transport flow ORB to the target whose *final* and *notify* bits are one and whose *queue* field specifies the queue to be shutdown. The initiator shall not signal any subsequent ORBs with the same *queue* value unless the target allocates the queue number upon future establishment of a connection. A data buffer may be associated with a transport flow ORB whose *final* bit is one.

If the direction of data transfer *via* the queue is from target to initiator, the initiator shall signal a control ORB whose buffer contains a SHUTDOWN QUEUE control request whose T2I_QUEUE parameter is equal to the value of the *queue* field in the final ORB. This avoids a deadlock with the target and insures that the final ORB is eventually fetched and processed by the target.

NOTE – If the direction of data transfer *via* the queue is from initiator to target, the initiator may signal a control ORB whose buffer contains a SHUTDOWN QUEUE control request whose I2T_QUEUE parameter is equal to the value of the *queue* field in the final ORB. This may be appropriate if the initiator wishes to abortively shutdown a queue or necessary if the target is unresponsive and not processing ORBs for the queue.

A target that receives a SHUTDOWN QUEUE request shall commence execution of all active ORBs for the queue identified by the I2T_QUEUE or T2I_QUEUE parameter. If the direction of data transfer is from the initiator to the target, the target shall not defer completion of any ORB for the queue solely because the receiving client application or service has not provided sufficient buffer space but shall complete the ORB without transferring all available data. Otherwise, if the direction of data transfer is from the target to the initiator, the target shall not defer completion of any ORB for the queue solely because the client application or service has not provided sufficient data. Regardless of the direction of data transfer, the *residual* field in the status block for the ORB shall report the actual data transfer.

Once the target completes any indicated data transfer for the final ORB, it shall mark the queue as provisionally shutdown and store completion status at the initiator's *status_FIFO*. The target may not yet release the resources associated with the queue. If the initiator signals any subsequent ORBs whose *queue* field identifies the provisionally shutdown queue, the target shall reject these with a *status* of one (invalid queue).

After the target has completed the final ORB, it shall discard any data generated by a client application or service for the provisionally shutdown queue. Because a service or client application at the initiator is unaware of the discarded data, if any, the shutdown of a queue used for data transfer from the target to the initiator may be disorderly (abortive) when requested by the initiator.

When the initiator receives completion status for the final ORB, it shall signal a control ORB whose buffer contains a RELEASE QUEUE control request. For a queue used to transfer data in only one direction, the initiator shall specify the I2T_QUEUE or T2I_QUEUE parameter, as appropriate, to identify the queue to be released. For a queue used to transfer data in either direction (*i.e.*, a queue used by a bi-directional, blocking connection), the initiator shall specify both parameters and their values shall be equal. If completion status for the control ORB indicates that the RELEASE QUEUE control request was not delivered to the target, the initiator shall either signal the control ORB again or reset the target by a write to its RESET_START register. Once completion status indicates successful receipt of the RELEASE QUEUE control request by the target, no additional initiator action is necessary. The RELEASE QUEUE control request has no corresponding response.

A target that receives a RELEASE QUEUE control request whose I2T_QUEUE or T2I_QUEUE parameter identifies a queue marked provisionally shutdown should release all resources allocated to the queue. Otherwise the target shall ignore the request. Once no active queues remain for the connection to which the queue was originally allocated, any additional connection resources should be released. The target shall not respond to a RELEASE QUEUE control request.

6.3.2.2 Queue shutdown by a target

When an application client or service at a target desires to shutdown a queue, it shall request the creation of a buffer that contains a SHUTDOWN QUEUE control request and signal the initiator to retrieve the control request by asserting the *attention* bit in a status block. For a queue used to transfer data in only one direction, the target shall specify the I2T_QUEUE or T2I_QUEUE parameter, as appropriate, to identify the queue to be shutdown. For a queue used to transfer data in either direction (*i.e.*, a queue used by a bi-directional, blocking connection), the target shall specify both parameters and their values shall be equal. Once completion status indicates successful receipt of the SHUTDOWN QUEUE request by the initiator, the target shall not defer completion of any ORB for the queue. When the direction of data transfer is from the initiator to the target, transport flow ORBs shall be completed without data transfer. Otherwise, when the direction of data transfer is from the target to the initiator, the completion of transport flow ORBs shall not be delayed solely because insufficient data is available. In both cases, the *residual* field in the status blocks stored for the transport flow ORBs shall report the actual data transfer.

NOTE – If the direction of data transfer *via* the queue is from target to initiator and an orderly shutdown is intended, the target's client application or service should cease generation of data and the target should complete all outstanding data transfers before issuing the SHUTDOWN QUEUE request.

An initiator that receives a SHUTDOWN QUEUE request shall signal a transport flow ORB to the target whose *final* and *notify* bits are one and whose *queue* field specifies the queue identified in the control parameters for the request. The initiator shall not signal any subsequent ORBs with the same *queue* value unless the target allocates the queue number upon future establishment of a connection. A data buffer may be associated with a transport flow ORB whose *final* bit is one.

Once the target completes any indicated data transfer for the final ORB, it shall mark the queue as provisionally shutdown and store completion status at the initiator's *status_FIFO*. The target may not yet release the resources associated with the queue. If the initiator signals any subsequent ORBs whose *queue* field identifies the provisionally shutdown queue, the target shall reject this with a *status* of one (invalid queue).

After the target has completed the final ORB, it shall discard any data generated by a client application or service for the provisionally shutdown queue. Because a service or client application at the initiator is unaware of the discarded data, if any, the shutdown of a queue used for data transfer from the initiator to the target may be disorderly (abortive) when requested by the target.

When the initiator receives completion status for the final ORB, it shall signal a control ORB whose buffer contains a RELEASE QUEUE control request. For a queue used to transfer data in only one direction, the initiator shall specify the I2T_QUEUE or T2I_QUEUE parameter, as appropriate, to identify the queue to be released. For a queue used to transfer data in either direction (*i.e.*, a queue used by a bi-directional, blocking connection), the initiator shall specify both parameters and their values shall be equal. If completion status for the control ORB indicates that the RELEASE QUEUE control request was not delivered to the target, the initiator shall either signal the control ORB again or reset the target by a write to its RESET_START register. Once completion status indicates successful receipt of the RELEASE QUEUE control request by the target, no additional initiator action is necessary. The RELEASE QUEUE control request has no corresponding response.

A target that receives a RELEASE QUEUE control request whose I2T_QUEUE or T2I_QUEUE parameter identifies a queue marked provisionally shutdown should release all resources allocated to the queue. Otherwise the target shall ignore the request. If no active queues remain for the connection to which the

queue was originally allocated, any additional connection resources should be released. The target shall not respond to a RELEASE QUEUE control request.

6.3.2.3 Simultaneous queue shutdown by initiator and target

Unaware of the other's actions, an initiator and a target might initiate shutdown of the same queue simultaneously. In this case, there is no guarantee of orderly shutdown.

If an initiator receives a SHUTDOWN QUEUE control request that identifies a queue for which a final ORB has already been signaled it shall take no action. Similarly, no action is required of a target when an initiator signals a final ORB at roughly the same time as the target issued a SHUTDOWN QUEUE request.

6.4 Queue status information

A target may transfer autonomous queue status information to an initiator when target data is available for a queue (*i.e.*, *target_data_pending* would be set to one in the status blocks stored for any transport flow ORBs for the queue) but the initiator has not signaled any ORBs for the queue. In this circumstance, the target is not able to indicate the presence of data except by an indirect route.

The target may indicate the availability of control information by setting the *attention* bit to one in any status block stored at the initiator's *status_FIFO*. The initiator should signal a control ORB whose *direction* bit is one in order to retrieve the control information from the target. When such an ORB is signaled, the target may transfer autonomous response information for the STATUS control function that contains a QUEUE_INFO parameter. The queue information notifies the initiator which queues have target data available.

If there are no ORBs in the target's task set, the target may communicate the *attention* bit to the initiator by means of an unsolicited status block. Once the initiator is aware of a target attention condition, it should signal a control ORB whose *direction* bit is one.

6.5 Logout and reverse logout

When PPDT client applications and services are idle—and expected to remain idle for some time—it may be desirable to relinquish the login. This frees the fetch agent, memory used to hold the working set of ORBs and other target resources allocated to the login for potential use by another initiator.

NOTE – Under normal conditions, a logout should not be performed until all queues other than queue zero are shutdown.

When an initiator wishes to release a login, it performs an SBP-2 logout. Contrariwise, a target that has no more immediate use for a login is unable to perform the logout directly. Instead, it creates a buffer that contains a REVERSE LOGOUT control request and signals the initiator to retrieve the control request by asserting the *attention* bit in a status block.

An initiator that receives a REVERSE LOGOUT control request should perform an SBP-2 logout as soon as possible. The reverse logout request by the target is advisory; the initiator may have information unavailable to the target that causes it to ignore the request. Whether or not the initiator honors the reverse logout request, it shall not return response information to the target.

7 Transport flow operations

Once a connection is established between a client application and a service, work is accomplished by the uni- or bi-directional flow of application-dependent data between the two. This section describes transport flow (and error recovery procedures) from the viewpoint of a queue instead of that of a connection; the reader may generalize from a single queue's operation to two coordinated queues that form a nonblocking bi-directional connection.

Service implementers select a datagram or stream mode of transport flow. The datagram mode is the simplest: there is a one-to-one relationship between ORBs, buffers and service data units (SDUs), as illustrated by Figure 18. The end of an SDU is demarcated by the *end_of_message* bit, which is always one when the datagram mode is used.

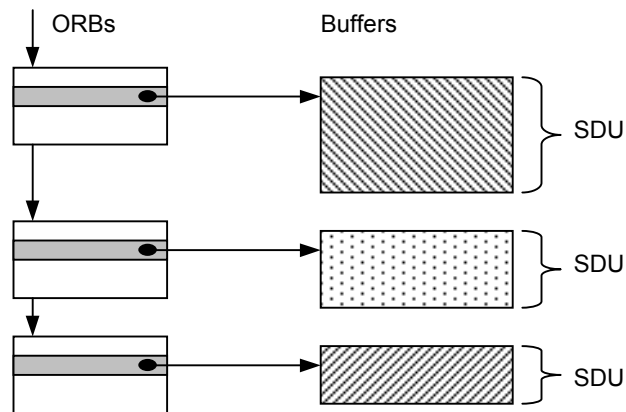

Figure 18 – Transport flow (datagram mode)

The stream mode permits SDU boundaries (e.g., the separation between pages or print jobs for a printer) to occur without regard for the boundaries between data buffers specified by different ORBs. Figure 19 illustrates the relationship between stream data, the ORBs that describe its buffers and the SDUs.

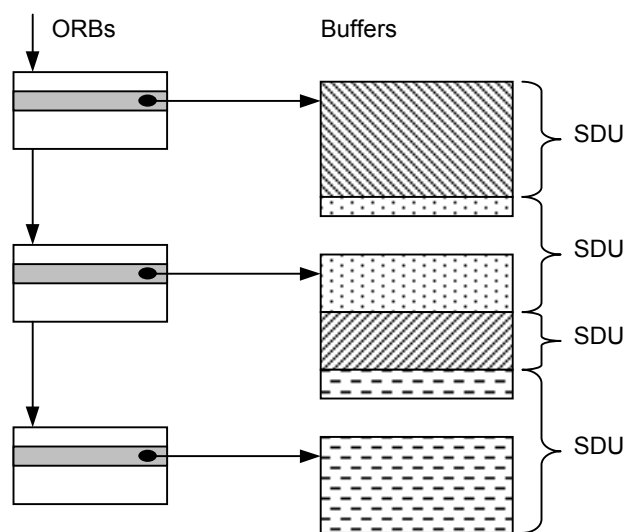

Figure 19 – Transport flow (stream mode)

In the preceding figure, the stream data is assumed to be self-descriptive: it may be parsed by its recipient without the necessity for the ORBs to explicitly mark the SDU boundaries. When in stream mode, the *end_of_message* bit may be used to signal the end of SDUs, whether or not they span more than one buffer, as illustrated by Figure 20.

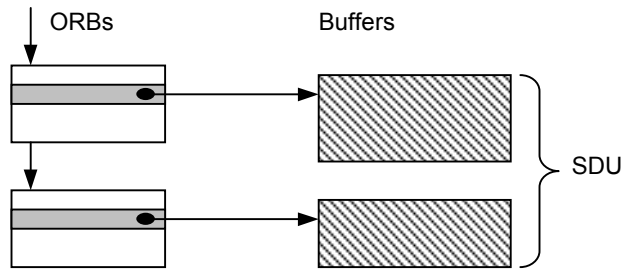

Figure 20 – Transport flow (stream mode with explicit SDUs)

In the preceding figure, the *end_of_message* bit is zero in all but the last ORB.

7.1 Data transfer to a target

Application data is transferred to a target by means of transport flow ORBs whose *direction* bit is zero. Within the limits of TASK_SLOTS allocated by the target at the time the connection (identified by the *queue* field) was established, the initiator may signal more than one such outstanding transport flow ORB to the task set at a time. ORB fetch latency is reduced if the initiator is permitted to have at least two such outstanding ORBs in the task set.

The target transport may use read requests that address the data buffer in arbitrary order so long as none of the data is presented to an application client out of order. Upon successful completion of the data transfer, the *residual* field in the status block shall be zero.

The transport flow mode, datagram or stream, established when the connection was created, governs behavior when the initiator has more data available than the target is capable of processing at one time. For stream mode, this condition cannot arise; the target transfers data within the limits of local memory, delivers the data to the application client and continues to transfer data as local memory is released by the application client. Barring an unrecoverable error in the data transport or application client, all of the data described by the ORB is eventually transferred.

When datagrams are used, the possibility exists that an SDU is larger than the maximum acceptable to the target. In this case, no data shall be transferred and the *residual* field shall indicate the error condition. Figure 21 shows the relationship between the initiator’s data buffer, the maximum SDU acceptable to the target and the value of *residual*. For simplicity, the figure assumes that no page table is used.

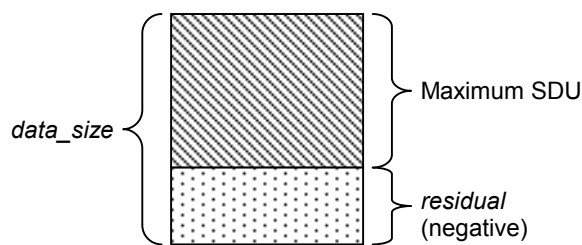

Figure 21 – Excess initiator data (datagram mode)

The initiator may calculate the target's maximum acceptable SDU size by adding *residual* to *data_size*.

7.2 Data transfer to an initiator

Application data is transferred to an initiator by means of transport flow ORBs whose *direction* bit is one. Within the limits of *TASK_SLOTS* allocated by the target at the time the connection (identified by the *queue* field) was established, the initiator may signal more than one such outstanding transport flow ORB to the task set at a time. ORB fetch latency is reduced if the initiator is permitted to have at least two such outstanding ORBs in the task set.

A target shall report the availability of data for a queue by setting *target_data_pending* bit to one in all status blocks stored for that queue's ORBs, regardless of the value of their *direction* bit, so long as there is untransferred data. If the initiator has signaled no ORBs for a queue, the target may set *attention* to one in the status block for any ORB. This requests the initiator to signal a control ORB to transfer queue information from the target (see 6.4) which in turn causes the initiator to signal transport flow ORBs whose *direction* bit is one for the queues with available data.

The target transport may use write requests that address the data buffer in arbitrary order so long as successful completion status is not reported to the initiator until the quantity of data identified by *residual* has been transferred. There is no requirement to store data in the entire buffer provided by the initiator before reporting successful completion status.

In stream mode, a transport flow ORB may be completed as soon as some data has been stored in the initiator's buffer; there is no requirement to defer completion of the ORB until the entire buffer provided by the initiator has been filled with data by the target. Figure 22 illustrates the positive *residual* that is reported in this case.

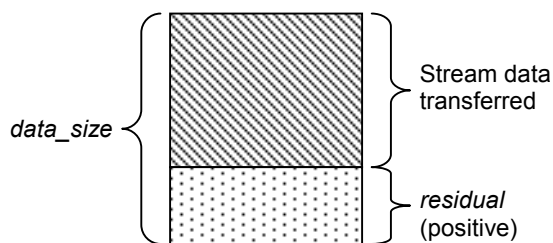

Figure 22 – Partial data transfer (stream mode)

The initiator may calculate the actual data transfer length by subtracting *residual* from *data_size*.⁴

The transport flow mode, datagram or stream, established when the connection was created, governs behavior when the target has more data available than the initiator is capable of processing at one time. For stream mode, this condition cannot arise; the target transfers data (supplied by its application client) within the limits of the data buffer provided by the initiator; if more data is available from the application client, the *target_data_pending* bit shall be one and the target awaits a subsequent ORB for the same queue whose *direction* bit is one. Unless an unrecoverable error occurs in the data transport, the target continues to fill initiator buffers so long as data is available.

When datagrams are used, the possibility exists that an SDU available at the target is larger than the data buffer provided by the initiator. In this case, no data shall be transferred and the *residual* field shall indicate the error condition. Figure 23 shows the relationship between the initiator's data buffer, the SDU available at the target and the value of *residual*. Although the figure assumes that no page table is used, the

⁴ This example assumes that no page table is used. If a page table were present, *data_size* would not specify the size of the buffer; the initiator would have to derive the buffer size from segment sizes specified by the page table.

relationships remain valid if a page table is present—except that the buffer size is summed from the page table elements instead of being directly available as *data_size*.

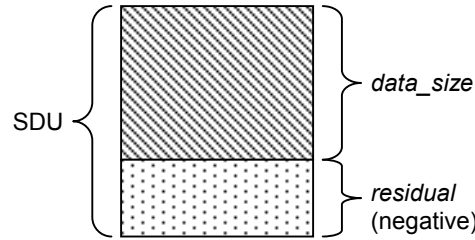

Figure 23 – Excess target data (datagram mode)

The initiator may calculate the minimum buffer size necessary to receive the SDU by subtracting *residual* from *data_size*.

7.3 Completion status

The target may signal completion status for a transport flow ORB by storing a status block to the initiator *status_FIFO* active for the login. All pending request subactions for the data transfer specified by the ORB and for any previously signaled ORBs with the same *queue* value shall be completed before the target stores a status block for the ORB to the initiator *status_FIFO*.

Not all values of the *resp*, *sbp_status*, *status* and *residual* fields are meaningful when considered collectively; the table below lists valid combinations within a status block. Field values other than those within the table shall not be reported by the target.

<i>resp</i>	<i>sbp_status</i>	<i>status</i>	<i>residual</i>	Comment
REQUEST COMPLETE	0	0	Zero or greater	Within the limits of the buffer provided, all available data has been transferred.
			Negative	Possible only in datagram mode: the SDU is too large to be transferred. When the <i>direction</i> bit in the ORB is zero, the maximum SDU is calculated as <i>data_size + residual</i> otherwise the maximum SDU is calculated as <i>data_size - residual</i> .
	nonzero	1 2 3 Unspecified	Unspecified	
TRANSPORT FAILURE	0x ₁₆ 4x ₁₆ 8x ₁₆ Cx ₁₆ FF ₁₆	Unspecified	Unspecified	When a transport failure occurs, it may be impossible to determine the requested data transfer length—and therefore impossible to calculate <i>residual</i> .
ILLEGAL REQUEST	FF ₁₆	Unspecified		No data has been transferred; because the ORB is malformed it is not possible to calculate <i>residual</i> .

<i>resp</i>	<i>sbp_status</i>	<i>status</i>	<i>residual</i>	Comment
VENDOR DEPENDENT	Unspecified			Definition of almost all fields in the status block is left to the device manufacturer.

7.4 Execution context for active ORBs

This document specifies a data transport between services and their application clients that is reliable across interruptions, such as a bus reset, that cause target task set(s) to be aborted. The data transport is not only robust in these circumstances, but also efficient. Data transfer may be quickly resumed without the necessity to redundantly move data already stored in or retrieved from an initiator's buffers. This is accomplished by cooperation between initiator and target in the use of the *signature* information field in transport flow ORBs. The *signature* field provides a method for the target to recognize an ORB previously active in an aborted task set.

In order to recognize and correctly resume execution for previously active ORBs, the target shall maintain context information (a history log) for each active ORB. An ORB is active from the time the target fetches it and commences data transfer⁵ up until the time completion status for the ORB is stored at the initiator's *status_FIFO* and either an *ack_pending* (with a subsequent response of *resp_complete*) or else an *ack_complete* are received by the target.

The exact details of context information maintained by a target are implementation-dependent, but the context shall be sufficient to correctly resume execution of a previously active ORB if signaled by the initiator after a task set abort. At a minimum, context information consists of the *direction*, *special* and *end_of_message* bits and the *queue* and *signature* fields for each active ORB as well as the status of data transfer—in progress or completed successfully or in error. Context information probably includes the original buffer size (derived from page table entries if a page table is associated with the ORB), the amount of data already transferred or remaining to be transferred and the offset of the current location within the data buffer.

Context information for an active ORB shall be discarded when the target receives a successful completion response after storing the status block for that ORB at the initiator's *status_FIFO* or when a successful completion response is received after storing a status block for a subsequent ORB for the same queue. An ORB is subsequent to another if it was signaled by the initiator after the first ORB. The receipt of a RELEASE_QUEUE request shall cause the target to discard context information for all active ORBs within the specified queue.

7.5 Error recovery

All of the events in the following table cause one or more of the target's task sets to be aborted; see ANSI NCITS 325-1998 for details. Unless otherwise noted, a target shall preserve execution context for active ORBs across these events.

⁵ The exact point in time at which an ORB becomes active is implementation-dependent and consequently difficult to define. An ORB is not yet active if the same ORB, signaled by an initiator after a bus reset, does not require context information in order for the target behavior to be essentially the same as if no bus reset had occurred. Whether or not data has been transferred is often an unreliable measure of an ORB's active status. For example, if a printer is designed to accumulate some minimum quantity of data before commencing image transfer to the medium, an ORB might not be active until the print engine started.

Event	AGENT_STATE.st	Comment
Unrecoverable transaction errors	DEAD	Store status block for faulted ORB with <i>resp</i> set to TRANSPORT FAILURE, if possible.
ABORT TASK SET		
Fetch agent reset (write to AGENT_RESET)	RESET	
TARGET RESET	DEAD	
Bus reset	RESET	For each login, a target shall retain, for at least <i>reconnect_hold</i> + 1 seconds after the bus reset, sufficient information to permit initiators to reconnect their logins. After this time, a target shall discard execution context for the task set of any initiator that failed to reconnect.
Command reset (write to RESET_START)		These events are equivalent; execution context for all ORBs in all task sets shall be discarded. Device operations should be halted and the device restored to an idle condition.
Power reset		

Unrecoverable transaction errors may be caused by a missing acknowledgement packet, a split transaction timeout, a data error or a retry limit exceeded. A missing acknowledgment by itself is not necessarily an unrecoverable error; the target shall wait a split timeout period before further action. If a transaction response is received within the split timeout period, there is no error. Otherwise, a split transaction timeout has occurred. In the case of a data error or a split transaction timeout, if the request was not addressed to an initiator *status_FIFO*, target may retry the transaction up to some implementation-dependent limit. Once the target deems a transaction error unrecoverable, it shall set the *resp* field in the status block stored for the faulted ORB to TRANSPORT FAILURE and transition the fetch agent to the dead state.

When an unrecoverable transaction error occurs for a request that does not address an initiator *status_FIFO*, the target should attempt to store completion status for the faulted ORB before transitioning the fetch agent to the dead state. This notifies the initiator that error recovery is necessary. If an unrecoverable transaction error occurs for a write request addressed to an initiator's *status_FIFO*, the target shall take no additional action. It is the initiator's responsibility to detect such an error, usually by means of a timeout.

After a task set has been aborted, an initiator's client applications and services may resume data transfer with the target's services and client applications on a queue by queue basis.

Data transfer between a client application and a service may have caused device operations to commence even if not all the data had been transferred before the task set was aborted. For this reason, it is essential for each queue to be resumed by using execution context for active ORBs to permit resumption of data transfer at the point at which it was interrupted.

NOTE – A prerequisite to the resumption of data transfer is the existence of a login (the initiator reconnects to the target if there was a bus reset) and a reset fetch agent (the initiator writes to AGENT_RESET if the target's fetch agent had been left in the dead state after the task set was aborted).

If the client application and service can reliably resume data transfer from the point it was interrupted, it may be unnecessary to cancel operations and flush buffers. In order for this method to work, the transport must be able to recognize resumption of an ORB active at the time the task set was aborted. The *signature* field in a transport flow ORB (see 5.1) provides a method by which previously active ORBs may be recognized if they are resubmitted after a task set abort.

For a particular queue, an initiator considers an ORB to be active if no completion status has been received from the target while a target considers an ORB active until positive acknowledgment of the receipt of completion status is signaled by the initiator. When an initiator wishes to resume data transfer for a particular queue from the point at which it was interrupted, it shall perform the following steps:

- a) If there were no active ORBs in the task set for the queue to be resumed, no action is necessary and the initiator may resume data transfer for the queue;
- b) Otherwise, for each previously active ORB for the queue, the initiator shall signal an equivalent ORB to the target fetch agent. Certain parts of the ORB shall remain unchanged: the *direction*, *special* and *end_of_message* bits and the *queue* and *signature* fields shall have the same values both before and after the task set abort. The *data_descriptor*, and *data_size* fields and the *page_table_present* may have different values but they shall describe a buffer of the same size and whose contents are identical to the buffer described by the ORB at the time it was aborted. If a bus reset caused the task set to be aborted, the *spd* and *max_payload* bits may differ as a result of changed topology between the initiator and target. An initiator shall signal equivalent ORBs in the same relative order within a queue as they had been prior to the task set abort.
- c) Once all the previously active ORBs for a particular queue have been signaled, the initiator may signal new ORBs in any order; these shall be interpreted by the target as if they are new.

When the target executes an ORB, the action taken depends upon the value of the *queue* and *signature* field, which together uniquely identify an execution context for the initiator. If the value of *signature* is equal to the signature of an ORB active for the queue at the time the task set was aborted, the target shall discard execution context information for any older, previously active ORBs for the same queue. An ORB is older than another ORB if it was signaled before the other ORB. If the value of the *signature* field is not equal to any previously active ORB for the queue, the target shall discard all execution context information for that queue.

When the *signature* field identifies execution context for a previously active ORB, the target operations are determined by the data transfer state at the time the task set was aborted. If the data transfer had completed, successfully or in error, and completion status had been written to the initiator's *status_FIFO* (but no response had been received from the initiator), the target simply stores the same completion status again. The target shall maintain context information for the ORB until the conditions specified by 7.4 are met. Otherwise, when data transfer had been in progress, the target shall resume data transfer from the point specified by the execution context for the ORB.

8 Configuration ROM

All devices compliant with this standard shall implement general format configuration ROM in accordance with IEEE Std 1394-1995, draft standards IEEE P1394a and IEEE P1212 and the additional requirements of this document. Targets compliant with this standard shall also conform to the configuration ROM requirements of ANSI NCITS 325-1998, except as specifically exempted by this document. General format configuration ROM is a self-descriptive structure; an example appropriate to a target is illustrated below.

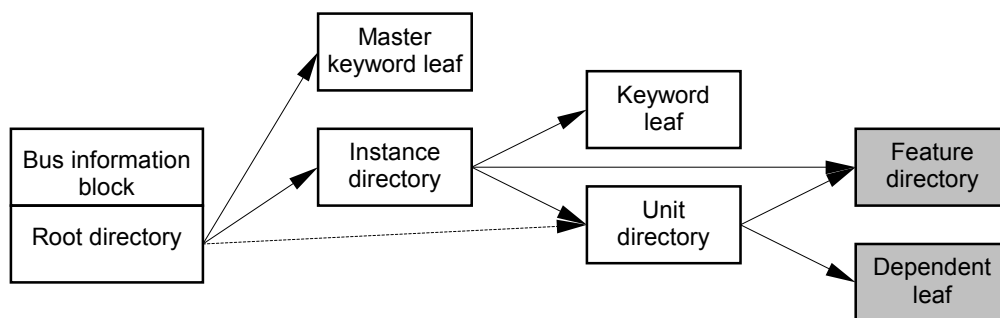

Figure 24 – Example configuration ROM hierarchy

With the exception of the feature directory and dependent leaf (shown shaded), all of the configuration ROM components shown above are required for targets compliant with this standard. The connection from the root directory to the unit directory (shown by a dashed line) is optional; instance directories are the preferred access routes for unit directories.⁶

In addition to the requirements of the referenced standards and draft standards, the first five quadlets of configuration shall conform to the format illustrated by Figure 25.

most significant															
bus_info_length					crc_length				crc						
31 ₁₆ ("1")					33 ₁₆ ("3")				39 ₁₆ ("9")			34 ₁₆ ("4")			
m	c	i	b	p	reserved	cyc_clk_acc				max_rec	max_ROM	generation	r	link_spd	
node_vendor_ID											chip_ID_hi				
chip_ID_lo															
least significant															

Figure 25 – First five quadlets of configuration ROM

The *bus_info_length* field shall have a value of four.

The *crc_length* field shall have a value of four plus the size, in quadlets, of the root directory. This indicates that the *crc* field is calculated for both the bus information block and the root directory—but not for any of the other configuration ROM data structures. The value of the *crc* field shall be calculated in accordance with draft standard IEEE P1212.

⁶ ANSI NCITS 325-1998 mandates a Unit_Directory entry in the root directory; this document is noncompliant in that respect and adheres to the more contemporary recommendations of draft standard IEEE P1212.

The second quadlet shall contain the string "1394" in ASCII characters as specified by draft standard IEEE P1394a.

The meaning and usage of the *irmc*, *cmc*, *isc*, *bmc* and *pmc* bits (abbreviated as *m*, *c*, *i*, *b* and *p*, respectively, in the figure above) and the *cyc_clk_acc*, *max_rec*, *max_ROM*, *generation*, *link_spd*, *node_vendor_ID*, *chip_ID_hi* and *chip_ID_lo* fields are specified by draft standard IEEE P1394a.

The *max_rec* field shall have a minimum value of five.

The *max_ROM* field shall have a minimum value of one.

8.1 Root directory

Configuration ROM for devices compliant with this standard shall contain a root directory. The root directory immediately follows the bus information block and has an address of FFFF F000 0414₁₆. Relevant mandatory and optional entries for the root directory are summarized by the table below; unless explicitly excluded, any optional root directory entries permitted by draft standard IEEE P1212 are also permitted by this document.

Table 3 – Root directory entries

Directory entry		Mandatory	Description
Name	Type		
Vendor_ID	I	Y	24-bit RID of the vendor that manufactured the device. This entry shall be immediately followed by a Textual_Descriptor entry. The addressed textual descriptor leaf (or leaves, if an intermediate textual descriptor directory exists) should contain an informal form of the vendor name easily recognizable by users.
Node_Capabilities	I	Y	Identifies which options of the CSR architecture are implemented.
Keyword_Leaf	L	Y	"Thumbnail" description of the characteristics of all instances implemented by the device.
Instance_Directory	D	Y	The instance directories provide a method to group unit architectures (software protocols) to identify shared physical components.
Unit_Directory	D		Unit_Directory entries are applicable only for targets. The use of Unit_Directory entries in the root directory is discouraged; designers should consult draft standard IEEE P1212 for more information.

The Vendor_ID entry shall contain the RID of the vendor that manufactured the device and shall be immediately followed by a Textual_Descriptor entry that specifies the location of either a textual descriptor directory or leaf. The referenced textual descriptor leaf or leaves should contain an informal (short) form of the company name of the vendor suitable for display.

A Keyword_Leaf entry is mandatory within the root directory and shall specify the location of the master keyword leaf in configuration ROM. The keywords included in this keyword leaf shall be the union of all keywords from all keyword leaves in the device's configuration ROM. Simple devices that implement only one instance may reuse its keyword leaf as the master keyword leaf.

At least one Instance_Directory entry is required in the root directory; each shall specify the location of an instance directory in configuration ROM.

8.2 Instance directories

Configuration ROM for devices compliant with this standard shall contain one or more instance directories, each of which describes the unit(s) implemented by a particular instantiation within the device. The mandatory and optional directory entries for an instance directory are specified by draft standard IEEE P1212.

All instance directories shall contain a Keyword_Leaf entry.

8.3 Feature directories

All unit directories compliant with the requirements of 8.5 or 8.6 may contain a Feature_Directory entry that specifies the location of a feature directory whose content and meaning are compliant with this clause. Configuration ROM may contain feature directories whose content and meaning are specified either by this standard, another organization or vendor. Relevant mandatory and optional entries for feature directories compliant with this document are summarized by the table below; unless explicitly excluded, any optional feature directory entries permitted by draft standard IEEE P1212 are also permitted by this document.

Table 4 – Feature directory entries

Directory entry		Mandatory	Description
Name	Type		
Specifier_ID	I	Y	Together these identify this standard as the document that specifies feature directory entries whose <i>key_ID</i> values are in the range 30 ₁₆ to 3F ₁₆ , inclusive.
Version	I	Y	
Service_ID	L		Collection of service ID text strings for services advertised by the instance or unit.

The Specifier_ID entry, whose 24-bit immediate value shall be 00 5029₁₆, and the Version entry, whose 24-bit immediate value shall be zero, identify this document as the specification of the feature directory.

The Service_ID entry, if present, shall have a *key* value of B0₁₆ and shall specify the location of a leaf in configuration ROM that contains one or more minimal ASCII text strings, each of which is the service ID of a service implemented by the instance. Services, whether implemented by an initiator or a target, are uniquely identified by their service ID, which may be registered with IANA (see Annex E). The format of a service ID leaf shall be identical to that specified by draft standard IEEE P1212 for keyword leaves.

NOTE – Vendor-dependent services should be identified by a service ID unlikely to be used by another vendor. One method is to include the vendor's name in the text string.

8.4 Keyword leaves

Each instance directory shall be characterized by a set of appropriate keywords placed in a keyword leaf referenced by a Keyword_Leaf entry in the instance directory. Additional keywords may be present in any keyword leaf, but their meaning and usage are beyond the scope of this standard. Instances that share exactly the same set of keywords may reference the same keyword leaf.

Table 5 – Recommended keywords

Keyword	Recommended usage
CAMERA	Captures digital images.
COLOR	More than grayscale capabilities are supported, but the device may operate in a grayscale only mode.
DISK	Nonvolatile storage, often rotating.
FAX	Implements facsimile protocols commonly used over public switched telephone networks (PSTN) or integrated services digital networks (ISDN).
IMAGE	Applicable to devices that capture, manipulate or transduce images.
INITIATOR	Identifies the presence of initiator capabilities independently of target capabilities.
MFP	Multifunction peripheral; indicates the grouping of separate functions (e.g., fax, printer and scanner) into a single controllable entity. Superior control may be available if the device is used as an MFP instead of as its separate functions.
MODEM	Data transmission protocols; may be dedicated or public switched telephone networks (PSTN).
PHOTO	Suited to the processing of photographic images.
PRINTER	Output device that marks removable media (hardcopy).
SBP-2	Applicable to all devices described by this standard.
SCANNER	Captures digital images, usually by means of relative motion between a sensor and a document.

8.5 Initiator unit directory

Configuration ROM for initiators compliant with this standard may contain one unit directory which specifies support for the reverse login facility (see 6.1). Relevant mandatory and optional entries for unit directories are summarized by the table below; unless explicitly excluded, any optional unit directory entries permitted by draft standard IEEE P1212 are also permitted by this document.

Table 6 – Initiator unit directory entries

Directory entry		Mandatory	Description
Name	Type		
Specifier_ID	I	Y	Together these identify this standard as the document that specifies the fundamental software interface for the unit.
Version	I	Y	
Feature_Directory	D		Additional information that describes features (usually independent of the software interface and command set) of the unit.

The Specifier_ID entry, whose 24-bit immediate value shall be 00 5029₁₆, and the Version entry, whose 24-bit immediate value shall be zero, identify the initiator as compliant with this standard.

There may be one Feature_Directory entry that specifies the location of a feature directory whose content and meaning are specified by this standard. There may be additional Feature_Directory entries that reference feature directories whose content and meaning are specified by another organization or vendor.

8.6 Target unit directories

Configuration ROM for targets compliant with this standard shall contain one or more unit directories, each of which specifies a software interface (unit architecture) for a device instance. Relevant mandatory and optional entries for unit directories are summarized by the table below; unless explicitly excluded, any optional unit directory entries permitted by draft standard IEEE P1212 or ANSI NCITS 325-1998 are also permitted by this document.

Table 7 – Target unit directory entries

Directory entry		Mandatory	Description
Name	Type		
Specifier_ID	I	Y	Together these identify ANSI NCITS 325-1998 as the document that specifies the fundamental software interface for the unit.
Version	I	Y	
Command_Set_Spec_ID	I	Y	Together these identify this document as the specification of the command set for the unit.
Command_Set	I	Y	
Management_Agent	I	Y	Provides the address of the SBP-2 MANAGEMENT_AGENT register for login to the device.
Unit_Characteristics	I	Y	
Logical_Unit_Number	I	Y	
Reconnect_Timeout	I		Describes the maximum reconnect timeout supported by a logical unit; a minimum value of ten seconds is recommended
Feature_Directory	D		Additional information that describes features (usually independent of the software interface and command set) of the unit.

The Specifier_ID entry, whose 24-bit immediate value shall be 00 609E₁₆, and the Version entry, whose 24-bit immediate value shall be 01 0483₁₆, identify the device as compliant with ANSI NCITS 325-1998, SBP-2.⁷

The Command_Set_Spec_ID entry, whose 24-bit immediate value shall be 00 5029₁₆, and the Command_Set entry, whose 24-bit immediate value shall be zero, identify the device as compliant with this document. The optional Command_Set_Revision entry, if present, shall have a 24-bit immediate value of zero.

The Unit_Characteristics entry shall specify a vendor-dependent *mgt_ORB_timeout* and an ORB size of eight quadlets (32 bytes). Consult ANSI NCITS 325-1998 for details.

Devices compliant with this standard shall contain a single Logical_Unit_Number entry for logical unit zero in each unit directory. The entry shall specify an unordered execution model (the *ordered* bit shall be zero). The *device_type* field shall be 1F₁₆, unspecified device type.

The Reconnect_Timeout entry is optional, but because connections between client(s) and service(s) are terminated by a reconnection failure, designers should give careful consideration to a value for

⁷ The names given are those used by draft standard IEEE P1212; they correspond to the names Unit_Spec_ID and Unit_SW_Version, respectively, in both ISO/IEC 13213:1994 and ANSI NCITS 325-1998.

max_reconnect_hold. Omission of this entry sets the default value to one second, which may not be appropriate for the intended application.

There may be one *Feature_Directory* entry that specifies the location of a feature directory whose content and meaning are specified by this standard. There may be additional *Feature_Directory* entries that reference feature directories whose content and meaning are specified by another organization or vendor.

8.7 Private unit directory

PPDT devices that implement no services (only client applications) and operate only as targets contain a special case of the target unit directory defined in 8.6: a “private” unit directory. The directory is private in that it is not addressed by a *Unit_Directory* entry anywhere in configuration ROM, neither from the root directory nor from any instance directory. Private unit directories cannot be discovered by a hierarchical parse of configuration ROM that starts with the root directory; they should not be enumerated by initiators nor should they be bound to device drivers.

A private unit directory shall not contain a *Directory_ID* entry; the directory ID for a private unit directory shall be implicit in its address within configuration ROM, as specified by draft standard IEEE P1212.

A private unit directory may be used in a REVERSE LOGIN request addressed to an initiator’s *MESSAGE_REQUEST* register; it provides the address of the *MANAGEMENT_AGENT* register intended as the destination of the login. A private unit directory may be used when the target has no other PPDT unit directories; it may also be used even if the target implements other PPDT unit directories.

Because private unit directories are not intended to be enumerable, there is little utility for them to contain *Keyword_Leaf* or *Feature_Directory* entries or device ID textual descriptors associated with the *Logical_Unit_Number* entry.

8.8 Device ID

IEEE Std 1284-1994 specifies the syntax of a device identifying string that contains the device’s vendor and model. Although the *Vendor_ID* and *Model_ID* entries defined by IEEE P1212 express equivalent information, PPDT devices may also include a device ID string in their configuration ROM. This clause specifies a uniform method for the inclusion of such a string.

The device ID string, if present, shall be a textual descriptor associated with the *Logical_Unit_Number* entry in a unit directory. The *width* and *language* fields in the textual descriptor shall be zero. The value of the *character_set* field shall be three; this indicates that the text string character set is US-ASCII, as specified by ANSI X3.4-1986. The format of the text string shall be as specified by IEEE Std 1284-1994 clause 7.6, except that it shall not commence with two bytes of length.⁸ The text string should include at least the *MANUFACTURER*, *MODEL*, *CLASS* and *COMMAND SET* fields (which may be abbreviated in the text string as *MFG*, *MDL*, *CLS* and *CMD* respectively).

Multifunction devices should identify their supported functions *via* multiple values assigned to the *CLASS* field. If characteristics of a particular function, *e.g.*, the command set, differ from other functions, the *CLASSINFO* field (which may be abbreviated in the text string as *CLI*) should be used to associate fields with a particular function. The *CLASSINFO* field is an extension, created by this standard, to the fields defined by IEEE Std 1284-1994. The syntax of the *CLASSINFO* field is *CLI:value*; where *value* shall be a function class specified by the *CLASS* field. All fields that follow a *CLI* field pertain to the class identified by *value* until the next *CLI* field in the device ID string.

⁸ The length, in bytes, of a textual descriptor’s text string may be calculated by subtracting the number of trailing pad (null) characters from $4 * \textit{descriptor_length}$.

Annex A (normative)

Minimum Serial Bus node capabilities

In addition to the minimum capabilities defined by IEEE Std 1394-1995, ANSI NCITS 325-1998 and draft standard IEEE P1394a, this annex specifies other capabilities or restrictions mandated by this standard.

A.1 Initiator capabilities

With the exception of configuration ROM and control and status registers, an initiator shall be capable of responding to block read or write requests with a *data_length* less than or equal to 64 bytes.

An initiator shall not attempt to login to a target unless the initiator is capable of responding to block read requests with a *data_length* less than or equal to $4 * ORB_size$, where *ORB_size* is obtained from the Unit_Characteristics entry in the target's configuration ROM.

For the largest value of *max_payload* specified in any command block ORB it signals to the target, an initiator shall be capable of responding to block read and write requests with a *data_length* less than or equal to $2^{max_payload + 2}$ bytes.

NOTE – The preceding is a requirement of ANSI NCITS 325-1998; although it duplicates information in that standard, it is included in this annex to simplify comprehension of the following requirement for the value of *max_rec*.

An initiator shall report the largest of these possible *data_length* values by setting the value of the *max_rec* field in the bus information block in its configuration ROM to a value equal to or greater than $(\log_2 data_length) - 1$.

A.2 Target capabilities

A target shall be capable of initiating block write requests with a *data_length* of at least 16 bytes.

Targets shall support management functions addressed to the MANAGEMENT_AGENT register as specified by the table below.

<i>function</i>	Support	Description
0	Mandatory	LOGIN
1	Mandatory	QUERY LOGINS
3	Mandatory	RECONNECT
4	Optional	SET PASSWORD (see ANSI NCITS 325-1998 Annex C)
7	Mandatory	LOGOUT
B ₁₆	Not supported	ABORT TASK
C ₁₆	Mandatory	ABORT TASK SET
E ₁₆	Not supported	LOGICAL UNIT RESET
F ₁₆	Mandatory	TARGET RESET

Annex B (normative)

Compliance with ANSI NCITS 325-1998

Subsequent to the approval of SBP-2 as an American National Standard, the IEEE P1212 working group commenced a revision of the CSR Architecture. This peer-to-peer data transport protocol, based upon SBP-2, conforms to the more recent recommendations and requirements of draft standard IEEE P1212, some of which conflict with normative requirements of ANSI NCITS 325-1998. This annex lists the points of divergence as well as areas for which this standard specifies SBP-2 implementation constraints not required by ANSI NCITS 325-1998.

B.1 Divergence from ANSI NCITS 325-1998

SBP-2 requires a target to attempt to store unsolicited status for all initiators logged in to a logical unit if it stores unsolicited status for any initiator logged into that logical unit. This requirement contains an implicit assumption that unsolicited status is pertinent to all initiators logged in to the same logical unit—but in the case of the *attention* bit, the information is relevant to only one initiator. As a consequence, this standard is written as if the first paragraph of 5.3.2 in ANSI NCITS 325-1998 were replaced with the following text:

"When a change in device status occurs that affects a logical unit, the target may store the status block shown in Figure 25 at the *status_FIFO* address provided by the initiator as part of a login request (see 5.1.3.1). If a target stores unsolicited status for any initiator logged-in to a logical unit it should attempt to store unsolicited status for other initiators logged-in to the same logical unit—but only if the unsolicited status information is pertinent to the other initiators."

SBP-2 was drafted before the IEEE P1212 working group started to revise the CSR Architecture, ISO/IEC 13213:1994. New efforts in the working group have rendered the SBP-2 requirement for a *Unit_Directory* entry in the root directory out of date. The revised CSR Architecture permits the SBP-2 legacy approach but it recommends a newer approach that makes unit directories the children of instance directories. This standard follows the more recent recommendations draft standard IEEE P1212 and therefore is not compliant with ANSI NCITS 325-1998.

B.2 Implementation requirements for ANSI NCITS 325-1998 initiators and targets

An initiator shall signal ORBs to targets in the same order as they are presented by its application clients and services. A target shall store completion status for ORBs in the same order as they are completed. An initiator shall report completion status in the same order as the status block(s) are written to the initiator's *status_FIFO*. These additional requirements are necessary to permit the ordered execution of ORBs within a single queue even though the target reports that it implements the SBP-2 unordered execution model in its configuration ROM.

If an event, such as the abortion of a task set, causes more than one ORB to simultaneously complete, an initiator shall report completion status to PPDT in the same order as which the ORBs were signaled to the target.

An initiator shall either permit PPDT to control the value of the *notify* bit for individual ORBs or shall set the *notify* bit to one for all ORBs.

Annex C
 (normative)

Control request and response parameters

The table below provides a quick reference to the parameters associated with particular control requests and successful responses; consult section 6 for details for a particular request or response. Optional parameters are shown by parentheses; the last column indicates whether or not the response information may be sent autonomously.

<i>ctrl_function</i>	Name	Requester	Request parameters	Response parameters	Autonomous response
1	CONNECT	Initiator	SERVICE_ID MODE (TASK_SLOTS)	Queue ID(s) ⁹ TASK_SLOTS	No
		Target	Queue ID(s) ⁹ SERVICE_ID MODE TASK_SLOTS	(TASK_SLOTS)	
2	SHUTDOWN QUEUE	Either	Queue ID(s) ¹⁰	No response allowed	
3	RELEASE QUEUE	Initiator	Queue ID(s) ¹⁰		
4	STATUS	Initiator	—	QUEUE_INFO	Target only
5	REVERSE LOGOUT	Target	—	No response allowed	

⁹ At least one queue ID parameter shall be present, either I2T_QUEUE or T2I_QUEUE, and both may be present. In the latter case the two queue ID parameters may identify different queues or the same queue.

¹⁰ When a bi-directional blocking queue is to be shutdown, both the I2T_QUEUE and T2I_QUEUE parameters shall be present and equal.

Annex D
 (normative)

Control and status registers

The control and status registers (CSRs) implemented by a target shall conform to the requirements defined by this standard and its normative references. The CSRs may be arranged in three principal categories:

- core registers defined by draft standard IEEE P1212 and required by either that standard or this document;
- bus-dependent registers required by IEEE Std 1394-1995; and
- unit architecture registers required by ANSI NCITS 325.1998.

The relevant standard shall be consulted for details of register definition and usage; the table below provides a quick reference that summarizes all CSRs used by this document. Except for the optional MESSAGE_REQUEST and MESSAGE_RESPONSE registers, all of the CSRs are mandatory.

Offset	Register name	Description
0	STATE_CLEAR	State and control information
4	STATE_SET	Sets STATE_CLEAR bits
8	NODE_IDS	Contains the 16-bit <i>node_ID</i> value used to address the node
C_{16}	RESET_START	Resets the node's state
$18_{16} - 1C_{16}$	SPLIT_TIMEOUT	Time limit for split transactions
$80_{16} - BC_{16}$	MESSAGE_REQUEST	Message area for target requests when no login exists
$C0_{16} - FC_{16}$	MESSAGE_RESPONSE	Message area for initiator responses to target requests addressed to MESSAGE_REQUEST.
210_{16}	BUSY_TIMEOUT	Controls transaction layer retry protocols
specified by configuration ROM	MANAGEMENT_AGENT	Login and other SBP-2 task management requests
specified by login response data	AGENT_STATE	Reports SBP-2 fetch agent state
	AGENT_RESET	Resets SBP-2 fetch agent
	ORB_POINTER	Address of current ORB
	DOORBELL	Signals SBP-2 fetch agent to refetch an address pointer
	UNSOLICITED_STATUS_ENABLE	Acknowledges the SBP-2 initiator's receipt of unsolicited status

Annex E (normative)

Service ID registration

Services implemented by PPDT devices are uniquely identified by their service ID, an ASCII string. When a service is widely available and presents an interface that is uniform across different implementations, the service ID should be registered. Registration promotes two goals: knowledge of the service and its interface is in the public domain and creation of service ID variants for essentially identical services is discouraged.

Service IDs may be registered with the Internet Assigned Numbers Authority (IANA), which maintains a registry suitable for this purpose. The registry may be accessed indirectly *via* a hyperlink from the IANA web site, <http://www.iana.org/numbers.html>, under the title "Protocol and Service Names" or it may be directly retrieved from <http://www.isi.edu/in-notes/iana/assignments/service-names>.

NOTE – Since PPDT devices that also implement RFC 2734, IPv4 over IEEE 1394, may function as Internet hosts, use of the IANA "Protocol and Service Names" registry is a natural extension of its original purpose.

The format of the protocol and service names registry is self-descriptive. A protocol or service name may be up to 40 characters (taken from the set of uppercase letters, digits and the punctuation character hyphen), shall start with a letter and end with a letter or digit.

Any individual or organization that wishes to register a service ID within this registry should use the following procedure:

- a) Consult <http://www.isi.edu/in-notes/iana/assignments/service-names> to determine whether or not the proposed service ID is already registered. If the service ID exists, determine if its interface is identical to that of the proposed service—in which case no registration is required. If there are functional differences between the registered service and the proposed service, create a unique service ID that is not yet registered;
- b) Send an Email to iana@iana.org; use the template below as a basis for the submission:

```
Subject: Protocol and Service Name Request
```

```
Please add the following service name and its description to the Protocol and Service Names List.
```

```
Service name: service_ID
```

```
Description: A brief description that references a document that specifies the service interface.
```

```
Contact name:
```

```
Contact Email:
```

```
Contact company:
```

- c) IANA will update the protocol and service names registry once the request is granted.

The descriptive information submitted with the service ID should specify a document that defines the service interface. Another possibility is to provide contact information for the organization or vendor responsible for the definition and maintenance of the service interface.

Annex F
 (informative)

Configuration ROM

Configuration ROM is located at a base address of FFFF F000 0400₁₆ within a node's address space. The requirements for general format configuration ROM for devices compliant with this standard are specified in section 8. This annex contains illustrations of typical configuration ROM for a variety of devices.

F.1 Bus information block and root directory

Figure F-1 below shows a typical bus information block, root directory and textual descriptor leaves for devices compliant with this standard. Not shown are the instance, feature and unit directories themselves; these may vary according to the complexity of the device and its supported software interfaces. Consult other clauses in this annex for examples of printers, scanners and other (multifunction) devices.

4	9	CRC (calculated)
3133 3934 ₁₆ (ASCII "1394")		
node_options (00FF 6012 ₁₆)		
node_vendor_ID		chip_ID_hi
chip_ID_lo		
4	Root directory CRC (calculated)	
03 ₁₆	vendor_ID	
81 ₁₆	Text descriptor leaf offset (3)	
0C ₁₆	node_capabilities (00 83C0 ₁₆)	
D8 ₁₆	Instance directory offset	
3		Text leaf CRC (calculated)
0	specifier_ID (0)	
width (0)	character_set (0)	language (0)
5859 5A00 ₁₆ (ASCII "XYZ ")		

least significant

Figure F-1 – Example bus information block and root directory

The CRC in the first quadlet is calculated on the following nine quadlets of configuration ROM, the bus information block and the root directory. Devices should not include all of configuration ROM within the coverage provided by this CRC; the other directories and leaves each contain their own CRC.

The *node_options* field represents a collection of bits and fields specified draft standard IEEE P1212. The value shown, 00FF 6012₁₆, represents basic characteristics of a device that is not isochronous capable.

This value is composed of a *cyc_clk_acc* field with a value of FF₁₆, a *max_rec* value of six, a *max_ROM* value of one and a *link_spd* value of two. The *max_rec* field encodes a maximum payload of 64 bytes in block write requests addressed to the target.

The *Node_Capabilities* entry in the root directory, with a *key* field of 0C₁₆, has a value where the *spt*, *64*, *fix*, *lst* and *drq* bits are all one. This is a minimum requirement for devices compliant with this standard.

The *Vendor_ID* entry in the root directory, with a *key* field of 03₁₆, is immediately followed by a textual descriptor leaf entry, with a *key* field of 81₁₆, whose *indirect_offset* value points to a leaf that contains an ASCII string that identifies the vendor (the XYZ company). Although the textual descriptor leaf utilizes minimal ASCII, a permissible variant might include a textual descriptor directory in order to provide multiple language support.

The *Instance_Directory* entry in the root directory, with a *key* field of D8₁₆, is the starting point for device discovery (enumeration) software to search configuration ROM for particular unit instantiations.

F.2 Feature directory

Devices compliant with this standard may implement a feature directory for each instance. An example of a feature directory, with its associated service ID leaf is illustrated by Figure F-2. Except for these generic features, additional content of the feature directory is device-dependent; see 8.3 for more details on the other directory entries that may be present.

3	Feature directory CRC (calculated)
12 ₁₆	specifier_ID (00 5029 ₁₆)
13 ₁₆	version (0)
B0 ₁₆	Service ID leaf offset (1)
1	Service ID leaf CRC (calculated)
53 5643 ₁₆ (ASCII "SVC")	0

least significant

Figure F-2 – Feature directory with service ID leaf

The *Specifier_ID* and *Version* entries, with a *key* field of 12₁₆ and 13₁₆, respectively, indicate that the format of the feature directory is specified by this document.

The *Service_ID* entry, with a *key* field of B0₁₆, points to the service ID leaf, which is in the same format as keyword leaves. The service ID leaf specifies a hypothetical service identified as "SVC".

F.3 Target unit directory

Targets compliant with this standard implement at least one unit directory in the format illustrated by Figure F-3. Devices that support more than one software protocol (unit architecture) may implement additional unit directories whose format is specified by other documents.

most significant		9		Unit directory CRC (calculated)	
12 ₁₆		specifier_ID (00 609E ₁₆)			
13 ₁₆		version (01 0483 ₁₆)			
38 ₁₆		command_set_spec_ID (00 5029 ₁₆)			
39 ₁₆		command_set (0)			
54 ₁₆		csr_offset (00 4000 ₁₆)			
3A ₁₆		Unit characteristics (00 0A08 ₁₆)			
14 ₁₆		Device type and LUN (0)			
81 ₁₆		Text descriptor offset (2)			
9A ₁₆		Feature directory offset			
12		Text leaf CRC (calculated)			
0		specifier_ID (0)			
width (0)	character_set (3)		language (0)		
4D ₁₆ ("M")	46 ₁₆ ("F")	47 ₁₆ ("G")	3A ₁₆ (":")		
58 ₁₆ ("X")	59 ₁₆ ("Y")	5A ₁₆ ("Z")	3B ₁₆ (";")		
4D ₁₆ ("M")	44 ₁₆ ("D")	4C ₁₆ ("L")			
51 ₁₆ ("Q")	51 ₁₆ ("Q")	51 ₁₆ ("Q")	51 ₁₆ ("Q")		
3B ₁₆ (";")	43 ₁₆ ("C")	4C ₁₆ ("L")	53 ₁₆ ("S")		
3A ₁₆ (":")	50 ₁₆ ("P")	52 ₁₆ ("R")	49 ₁₆ ("I")		
4E ₁₆ ("N")	54 ₁₆ ("T")	45 ₁₆ ("E")	52 ₁₆ ("R")		
3B ₁₆ (";")	43 ₁₆ ("C")	4D ₁₆ ("M")	44 ₁₆ ("D")		
3A ₁₆ (":")	50 ₁₆ ("P")	53 ₁₆ ("S")	32 ₁₆ ("2")		
3B ₁₆ (";")	0				
		least significant			

Figure F-3 – Unit directory for peer-to-peer data transport (PPDT) protocol target

The Specifier_ID and Version entries, with a key field of 12₁₆ and 13₁₆, respectively, indicate that the format of the unit directory is specified by ANSI NCITS 325-1998.

The Command_Set_Spec_ID and Command_Set entries, with key fields of 38₁₆ and 39₁₆, respectively, indicate that the target use the peer-to-peer data transport (PPDT) protocol specified by this document.

The Management_Agent entry in the unit directory, with a *key* field of 54₁₆, has a *csr_offset* value of 00 4000₁₆ that indicates that the management agent CSR has a base address of FFFF F001 0000₁₆ within the node's memory space.

The Unit_Characteristics entry in the unit directory, with a *key* field of 3A₁₆, has an immediate value of 00 0A08₁₆. This indicates a target that is expected to complete task management requests (including login) within five seconds and fetches 32-byte ORB's.

The Logical_Unit_Number entry in the unit directory, with a *key* field of 14₁₆, has an immediate value of zero that indicates a device that may reorder tasks without restriction and has a logical unit number of zero. The textual descriptor associated with the Logical_Unit_Number contains a device ID string (see 8.8). In this example, the string "MFG:XYZ;MDL:QQQQ;CLS:PRINTER;CMD:PS2;" indicates a model QQQQ device manufactured by the XYZ company. The device class is PRINTER and the command set supported is Postscript Level 2.

In this example, the unit's parent instance directory is assumed to reference an optional feature directory. Consequently, at least one Feature_Directory entry in the unit directory is required to address the same feature directory. See Figure F-2 for an example of a typical feature directory.

F.4 Scanner with a single unit architecture

The configuration ROM for a simple device, such as a scanner, that implements only one software protocol (unit architecture) utilizes the bus information block and root directory structure already described in Figure F-1. An example instance directory and its associated keyword leaf is illustrated by Figure F-4.

most significant			
3		Instance directory CRC (calculated)	
99 ₁₆	Keyword leaf offset (3)		
DA ₁₆	Feature directory offset		
D1 ₁₆	Unit directory offset		
4		Keyword leaf CRC (calculated)	
43 ₁₆ ("C")	4F ₁₆ ("O")	4C ₁₆ ("L")	4F ₁₆ ("O")
52 ₁₆ ("R")	0	53 ₁₆ ("S")	43 ₁₆ ("C")
41 ₁₆ ("A")	4E ₁₆ ("N")	4E ₁₆ ("N")	45 ₁₆ ("E")
52 ₁₆ ("R")	0	0	
		least significant	

Figure F-4 – Instance directory and keyword leaf for a scanner

The Keyword_Leaf entry, with a *key* value of 99₁₆, points to a keyword leaf that contains the keywords COLOR and SCANNER.

Since this is a simple device that supports a single software protocol (unit architecture), there is only one Unit_Directory entry, with a *key* value of D1₁₆, in the instance directory.

F.5 Printer with multiple unit architectures

The configuration ROM for a more complex device, such as a printer that implements more than one software protocol (unit architecture) also utilizes the bus information block and root directory structure already described in Figure F-1. An example instance directory and its associated keyword leaf is illustrated by Figure F-5.

most significant			
4		Instance directory CRC (calculated)	
99 ₁₆	Keyword leaf offset (4)		
DA ₁₆	Feature directory offset		
D1 ₁₆	Unit directory offset (PPDT protocol)		
D1 ₁₆	Unit directory offset (DPP)		
6		Keyword leaf CRC (calculated)	
50 ₁₆ ("P")	48 ₁₆ ("H")	4F ₁₆ ("O")	54 ₁₆ ("T")
4F ₁₆ ("O")	0	50 ₁₆ ("P")	52 ₁₆ ("R")
49 ₁₆ ("I")	4E ₁₆ ("N")	54 ₁₆ ("T")	45 ₁₆ ("E")
52 ₁₆ ("R")	0	44 ₁₆ ("D")	50 ₁₆ ("P")
50 ₁₆ ("P")	0	53 ₁₆ ("S")	42 ₁₆ ("B")
50 ₁₆ ("P")	2D ₁₆ ("-")	32 ₁₆ ("2")	0
		least significant	

Figure F-5 – Instance directory and keyword leaf for a multiple protocol printer

The Keyword_Leaf entry, with a key value of 99₁₆, points to a keyword leaf that contains the keywords PHOTO, PRINTER, DPP and SBP-2.

Since this target supports multiple software protocols (unit architectures) for the same physical instance of the print engine, there are two Unit_Directory entries in the instance directory, one that references a unit directory compliant with this standard and one that references a Direct Print Protocol (DPP) unit directory.

F.6 Multifunction device with uniform unit architectures

Although the configuration ROM for a multifunction peripheral (MFP) is assembled from the same components already described in earlier examples, the instance hierarchy is more complicated and best understood in reference to Figure F-6. In this example, the MFP combines FAX, printer and scanner capabilities into a single device. In order to control the device as an MFP, software written for the MFP unit architecture would login to the unit directory shown shaded. The MFP driver would be responsible to multiplex the FAX, printer and scanner functions and present an appropriate interface to the user. However, even in the absence of an MFP driver, other drivers that understand individual FAX, printer or scanner unit architectures could discover and control the instances for these separate functions—but not necessarily coordinate their functions.

This example assumes that the MFP utilizes the same command sets for all of its functions. That is, the unit architectures are uniformly DPP, PPDT extensions to SBP-2 or some other command set. An MFP

could support multiple unit architectures, in which case each of its instance directories could reference more than one unit directory (as illustrated in F.5).

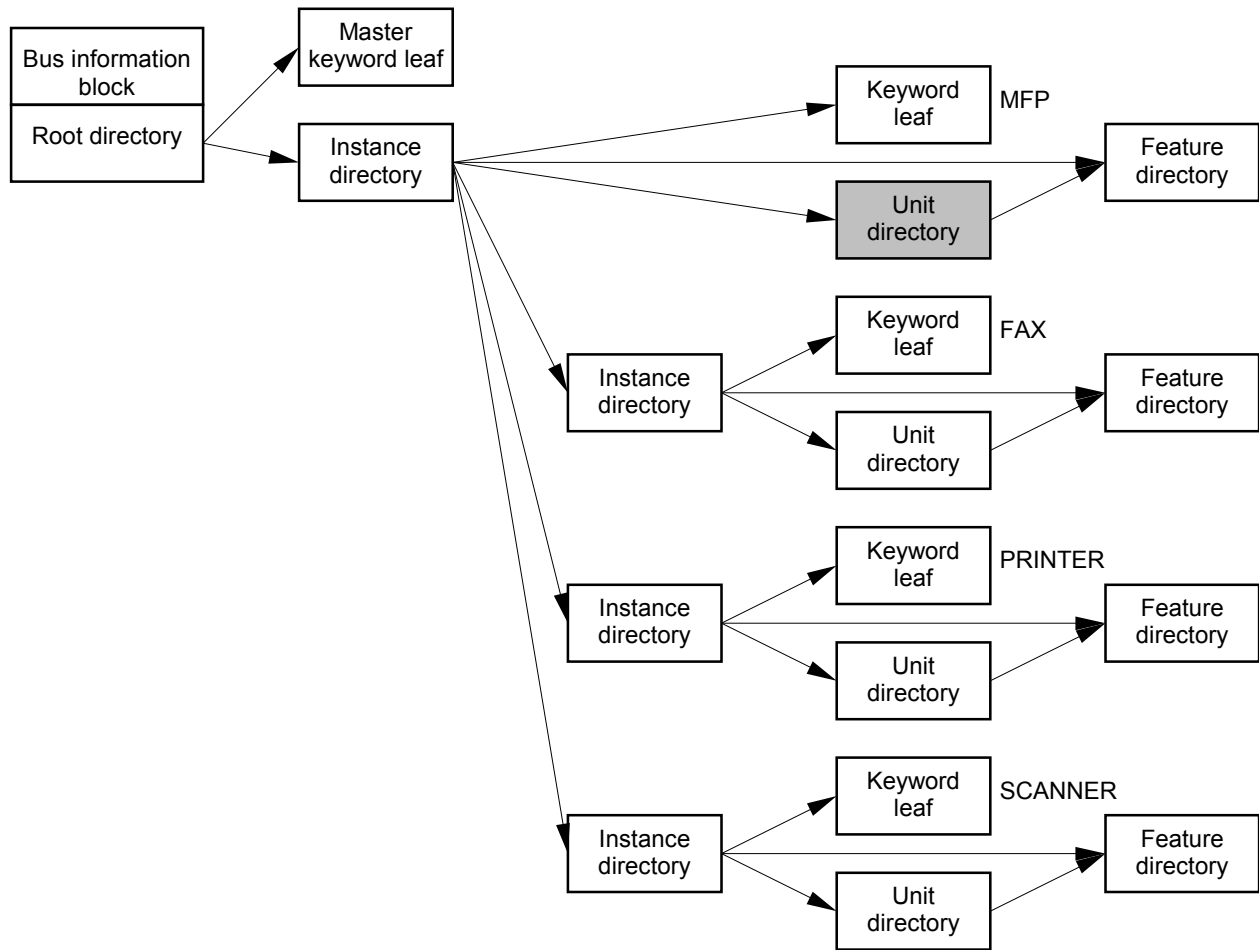

Figure F-6 – Example MFP configuration ROM hierarchy

A navigation of the instance directories starts at the top of the hierarchy, with the instance directory that is a direct descendent of the root directory. An example of an instance directory for an MFP with three basic functions bundled within it is given by Figure F-7.

6		Instance directory CRC (calculated)	
99 ₁₆	Keyword leaf offset (6)		
DA ₁₆	Feature directory offset		
Unit directory offset			
D8 ₁₆	Instance directory offset		
D8 ₁₆	Instance directory offset		
D8 ₁₆	Instance directory offset		
1		Keyword leaf CRC (calculated)	
4D ₁₆ ("M")	46 ₁₆ ("F")	50 ₁₆ ("P")	0

least significant

Figure F-7 – Instance directory and keyword leaf for a multifunction peripheral (MFP)

The Keyword_Leaf entry, with a key value of 99₁₆, points to a keyword leaf that contains the keyword MFP. If this information is displayed to a user, it should indicate an instance of a multifunction peripheral. Perhaps the display might invite the user to request more information and determine the number and type of functions supported.

The Unit_Directory entry, with a key value of D1₁₆, references the unit architecture shown shaded in Figure F-6.

The three Instance_Directory entries, with key values of D8₁₆, create a hierarchy that organizes the MFP into three component functions, each of which may be controlled separately. In order to determine the nature of each instance's function it is necessary to navigate configuration to the next lower level in the instance hierarchy and examine the keywords associated with each instance directory.

Examples of instance directories for the FAX, printer and scanner functions are not illustrated because they are fundamentally similar to the examples already provided by Figure F-4 and Figure F-5. The salient difference between these instance directories is in the content of their keyword leaves; these should contain the keywords FAX, PRINTER and SCANNER respectively and may contain other keyword modifiers.

F.7 Initiator unit directory

Initiators compliant with this standard may implement a unit directory to permit other devices to discover the initiator's PPDT capabilities. An example of a unit directory, with an associated service ID leaf is illustrated by Figure F-8. Except for these generic features, additional content of an initiator unit directory is device-dependent; see 8.5 for more details on the other directory entries that may be present.

NOTE – Although this example may be understood in conjunction with a typical bus information block and root directory shown by Figure F-1, the root directory would contain a Unit_Directory entry that references the initiator unit directory. The initiator unit directory should not be accessible *via* the instance directories.

most significant	3	Unit directory CRC (calculated)
	12 ₁₆	specifier_ID (00 5029 ₁₆)
	13 ₁₆	version (0)
	B0 ₁₆	Service ID leaf offset (1)
	1	Service ID leaf CRC (calculated)
	53 5643 ₁₆ (ASCII "SVC")	0
		least significant

Figure F-8 – Initiator unit directory with a service ID leaf

The Specifier_ID and Version entries, with *key* fields of 12₁₆ and 13₁₆, respectively, indicate that the format of the unit directory is specified by this document.

Unlike the target unit directory illustrated by Figure F-3, there is neither a Command_Set_Spec_ID nor a Command_Set entry. An initiator unit directory is not compliant with ANSI NCITS 325-1998.

The Service_ID entry, with a *key* field of B0₁₆, points to the service ID leaf, which is in the same format as keyword leaves. The service ID leaf specifies a hypothetical service identified as "SVC".